

# Ultrasonic Flowmeter

# UFL-30

## Installation & Operation Manual







## Safety Precautions

The following safety precautions contain important information pertaining to the safe use of the Ultrasonic Flowmeter. Read this text carefully and make sure to fully understand its contents before installing and operating this equipment. Follow directions given herein at all times when operation. TOKYO KEIKI INC. is not at all liable for an injury and/or a damage resulting from misuse of this equipment by the user that is contrary to these cautionary notes.

For quick reference, store this manual in a designated location with easy access (preferably near the equipment).

In this manual and on the equipment, the following safety symbols are used to ensure the equipment is used safely and to protect operators and property from possible hazards or damage. Read the explanations below carefully and familiarize yourself with the symbols before reading the manual.

### Safety symbols

 <b>DANGER</b>	Indicates that incorrect usage can result directly in death or serious injury to the operator.
 <b>WARNING</b>	Indicates that incorrect usage may result in loss of life or serious injury to the operator.
 <b>CAUTION</b>	Indicates that incorrect usage may result in injury to the operator or damage to the equipment.
	Indicates referring to information for usage of the function or features. (Put on the equipment)
<b>NOTE</b>	Indicates attention to information for usage of the function or features.
	Indicates Protective conductor terminal
	Indicates Earth terminal (Functional earth terminal)
	Indicates near by power supply voltage line.
~	Indicates Alternating current, "AC".
==	Indicates Direct current, "DC".

**Name of each part**

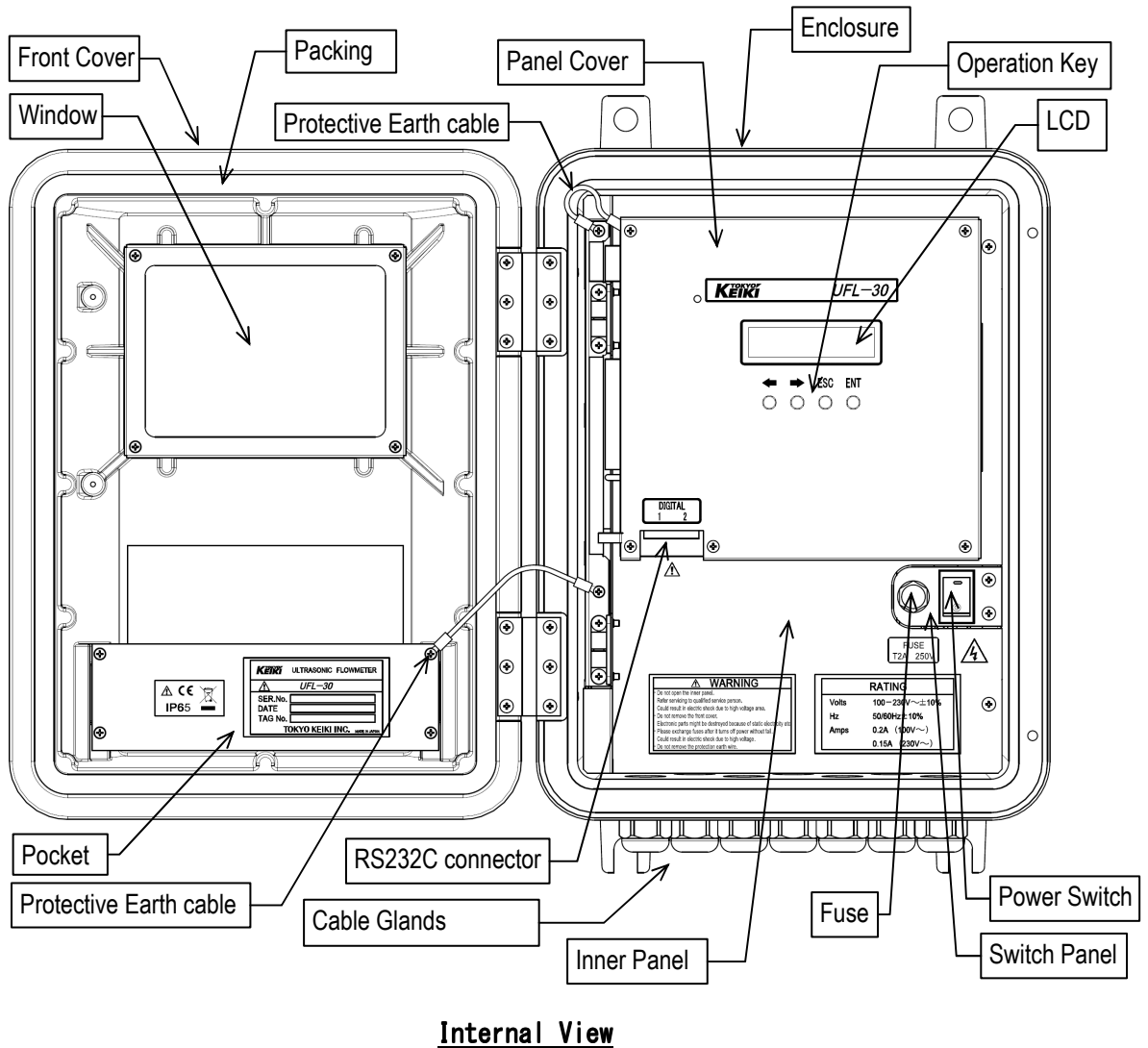
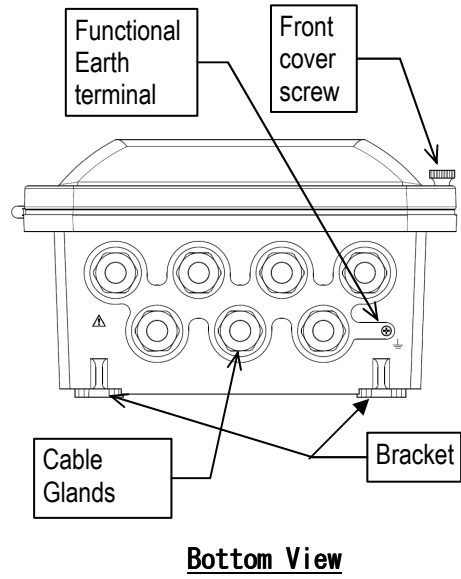
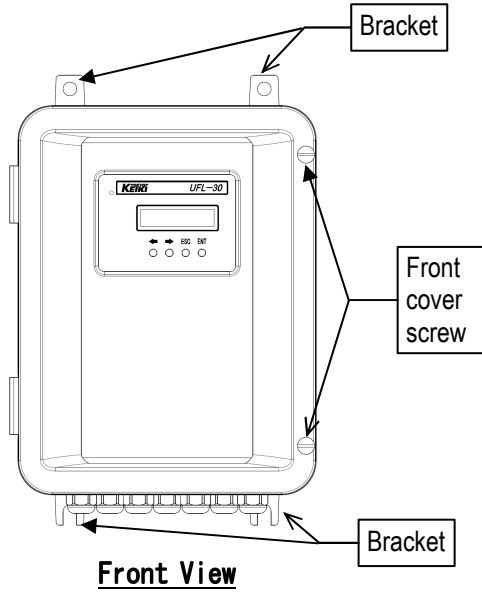

# Labels and attached place

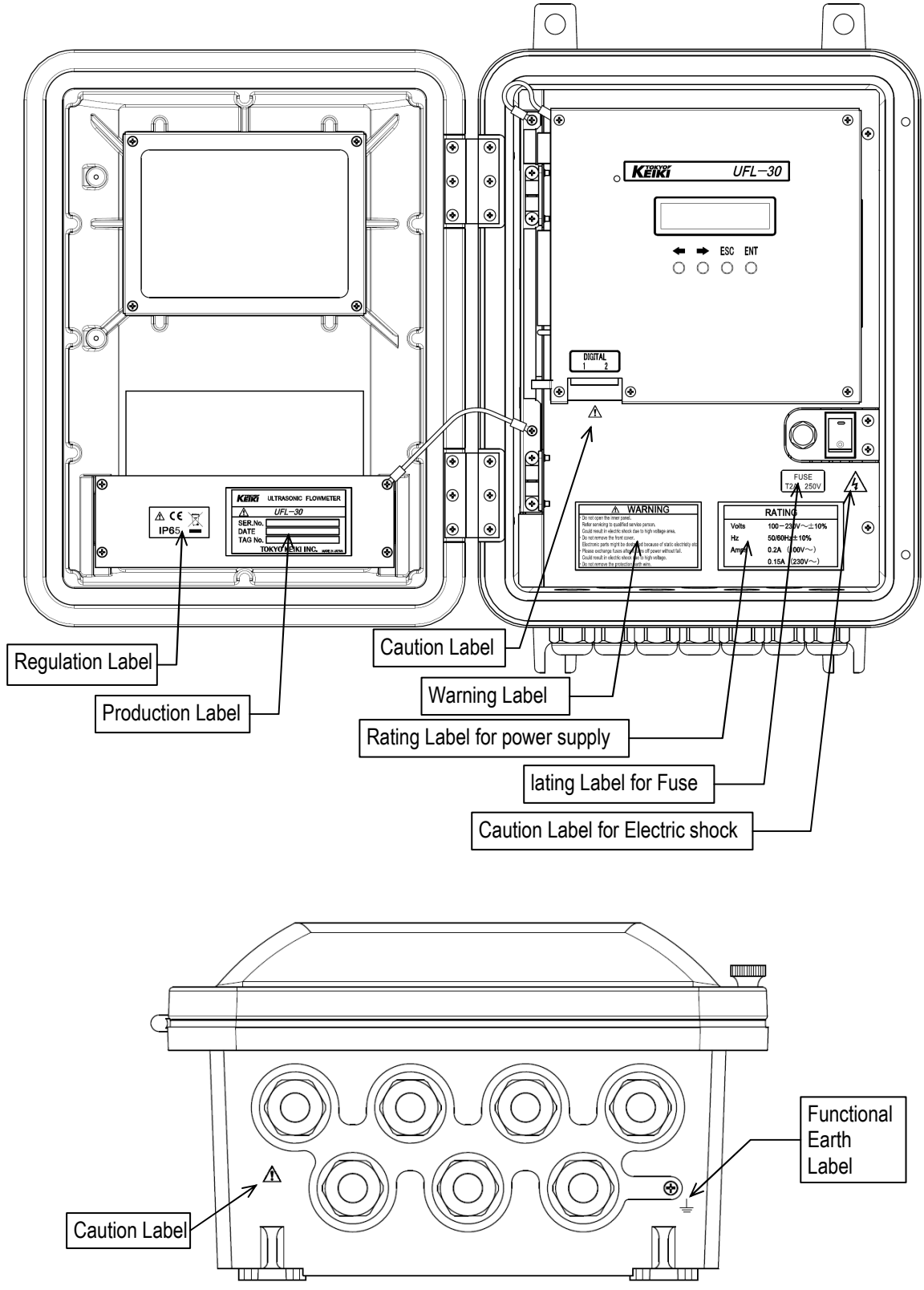

Labels attached inside of the equipment are as follows.

[Warning Label]

Indicates that incorrect usage may result in death or serious injury to the operator.

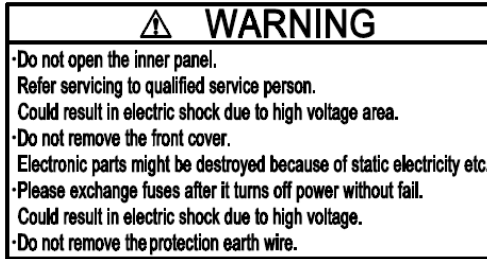

[Caution Label]

Indicates that incorrect usage may result in loss of life or serious injury to the operator.



[Rating Label]

Power supply rating

[ For AC power supply type ]

RATING	
Volts	100–230V $\sim$ $\pm$ 10%
Hz	50/60Hz $\pm$ 10%
Amps	0.2A (100V $\sim$ ) 0.15A (230V $\sim$ )

[ For DC power supply type (Option) ]

RATING	
Volts	24V $\equiv$ $\pm$ 20%
Amps	0.42A

Fuse rating

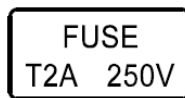

Regulation



Earth

[ For protective earth ]

[ For functional earth ]



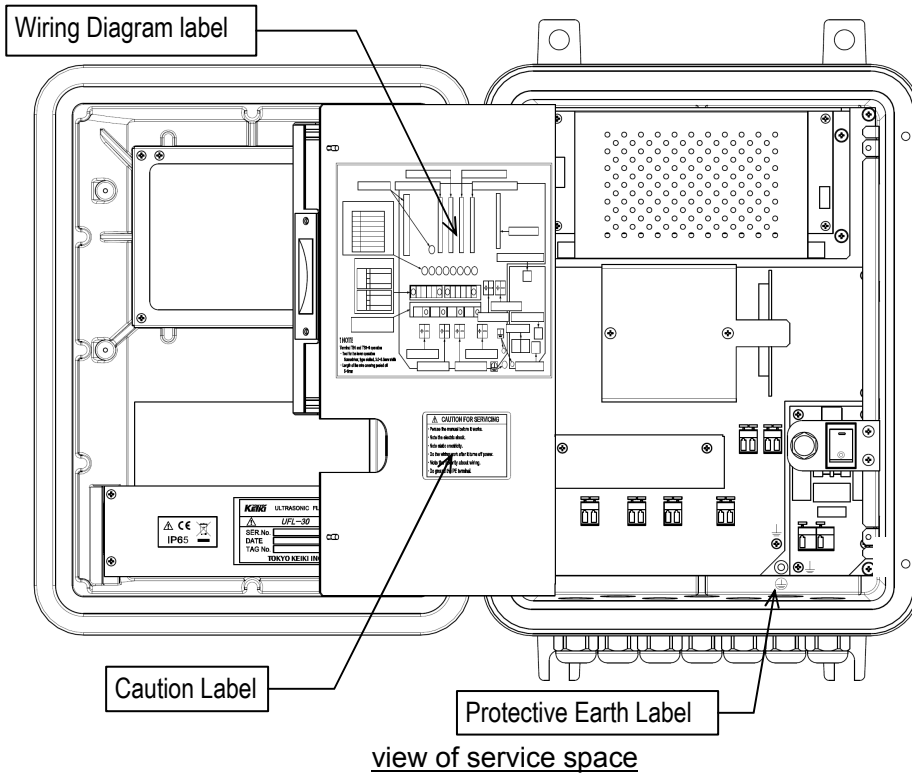

[Wiring Diagram for AC power supply type]

[Wiring diagram for DC power supply type]

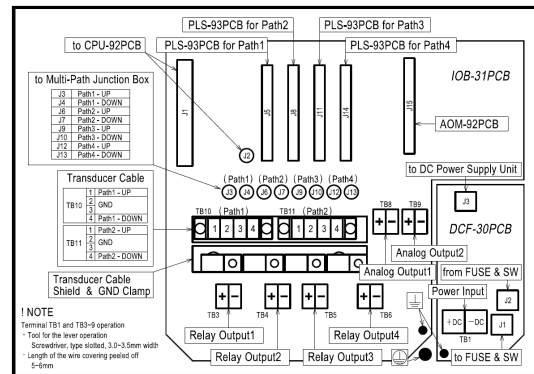
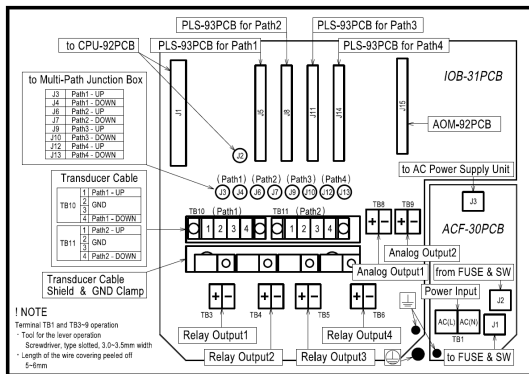

[Caution Label]

**⚠ CAUTION FOR SERVICING**

- Peruse the manual before it works.
- Note the electric shock.
- Note static electricity.
- Do the wiring work after it turns off power.
- Note the polarity about wiring.
- Do ground the PE terminal.

[Protective Earth Label]



## Usage Precautions

This instrument is used to measure flow quantities by means of ultrasound. For safe usage and optimum performance of the flowmeter, always operate the instrument according to the usage precautions below.



### WARNING

Do not open the inner panel while feeding power.  
Do not modify and disassemble the unit.  
These actions may result in electrical shock or equipment damage.



### CAUTION

1. Failure to comply with one or more of the following conditions may result in poor measurement performance or incorrect measurement values.
  - Use an appropriate power supply rated for the voltage range designated in the specifications.
  - Fill pipes entirely with water.
  - Be sure bubbles or particles that might interfere with ultrasonic waves are absent during measurement.
  - Position the transducer in accordance with the required straight pipe length.
  - Do not subject the transducer to vibration or mechanical shock.
  - Place the flowmeter unit, transducer and cable in a location without noise interference.
  - Use the equipment within the predetermined ambient temperature and humidity range.
  - Do not remove cable glands that attached with main unit. In case of removal it, main unit can not satisfy performance of protection class.
2. If the signal level is below the minimum detection requirement of the instrument, the LCD display of the main unit will display the R (no wave reception) alarm.  
The D (disturbance) alarm is triggered when an abnormal measurement value is detected.  
Note that in both cases the flowmeter may display the flow value preceding the alarm.
3. Be sure to use the instructions in the Manual when changing settings on the main flowmeter unit (maximum flow, integration units, etc.). Incorrect settings will result in poor performance or incorrect measurement values (output signals).
4. If this manual is lost, contact the nearest dealership.

## Introduction

Thank you for your selecting our Ultrasonic Flowmeter.

This Manual includes detailed explanations regarding safety cautions, structure, set up, operation, troubleshooting, and maintenance of the Ultrasonic Flowmeter.

Read this manual carefully before operation to ensure an adequate understanding of the equipment.

## Proper use of the Operation Manual

The following points must be observed:



### CAUTION

1. Carefully read the Manual. The contents of this Manual are very important and should be read completely.
2. Store the Manual in a safe location. The Manual is essential for appropriate operation of the equipment. Store the manual in a safe and accessible location. The storage location and person in charge should be determined after careful consideration.
3. Ensure that the Manual is supplied to the operator of the equipment. The representative or dealer of this equipment must provide this Manual to the user who will actually operate the equipment.
4. The Manual must be replaced if lost or damaged. If the Manual is lost, contact the representative. A new manual is available for purchase.
5. Ensure that the warning label is properly attached. If the warning label is illegible or has come off, contact the manufacturer to purchase a new label.

## Precautions regarding the Manual

This Manual was written in accordance with the standard specifications of the original instrument.

In case of discrepancies between written specifications and approved drawings, the drawings should be given precedence.

## Restrictions and precautions necessary to maintain the equipment

The following items must be observed in order to maintain the equipment.



### CAUTION

1. Do not drop or bump the unit and the transducer.
2. Do not use the unit in environmental conditions (ambient temperature, ambient humidity) other than those prescribed in this manual.
3. Do not use the unit with a power supply other than the one prescribed in this manual.
4. Do not use damaged or worn-out cables (power cables, coaxial cables, signal cables).
5. The device contains high-voltage circuit boards. Never, under any circumstances, touch terminals or the inside of the device when the power is on.
6. The device is operated via the opened panel (display, keyboard) of the main flowmeter unit. Do not manipulate electrical circuits (printed circuit boards, electrical parts, etc.) inside the panel.
7. Under no circumstances attempt to modify or disassemble the instrument. Contact the manufacturer in the event of a malfunction.
8. Do not use the unit and/or accessories in restricted hazardous areas.



Safety Precaution .....	(1)
Safety Symbols .....	(1)
Name of each parts .....	(2)
Labels and attached place .....	(3)
Usage Precaution .....	(6)
Introduction .....	(7)
Proper use of the Manual .....	(7)
Precautions regarding to the Manual .....	(7)
Restrictions and precautions necessary to maintain the equipment .....	(7)

## INDEX

### I. Installation

Here you can see how to install flowmeter system.

I-1. Configuration .....	I-3
I-2. Installation and Wiring .....	I-8
I-2-1 Setup Procedure .....	I-8
I-2-2 Selection of transducer setup position .....	I-10
I-2-3 Placement of the main unit .....	I-12
I-2-4 Wiring .....	I-12
I-2-5 Multi-Path Connection to main unit .....	I-19
I-2-6 Functional ground connection .....	I-24
I-2-7 Installation of disconnection device for power line .....	I-24
I-2-8 Insulation for DC power source .....	I-24
I-2-9 Transducer Installation procedure .....	I-25
I-2-10 Transducer cable treatment for main unit .....	I-36
I-2-11 Cable connection treatment with chemical binder.....	I-39
I-2-12 Installation Outfit .....	I-41
I-2-13 Input parameters by Commissioning software.....	I-42

### II. Operation

Here you can see how to operate main unit.

II-1. Function .....	II-5
II-2. Operation .....	II-19
II-2-1 Main operating unit layout.....	II-19
II-2-2 Startup and shutdown procedure.....	II-20
II-2-3 LCD and operating keys.....	II-20
II-2-4 Display layout and description .....	II-21
II-2-4-1 Measurement display .....	II-21
II-2-4-2 Menu screen .....	II-22
II-2-5 Menu Overview in LCD .....	II-23
II-2-6 How to operate .....	II-24
II-2-7 Output operating during aberrations in measurement .....	II-47
II-2-8 Error Message.....	II-49

### III. Other

Here you can see concerned with Maintenance, Specification or Measuring Principle.

III-1. Maintenance and Inspection .....	III-3
III-1-1 Transducer and main unit maintenance and inspection .....	III-3
III-1-2 Parts like reference .....	III-3
III-2. General Specifications .....	III-5
III-2-1 Overall Specification .....	III-5
III-2-2 Main unit specification .....	III-6
III-2-3 Transducer .....	III-12
III-2-4 Accessories .....	III-13
III-2-5 Dimensions .....	III-14
III-2-6 Analog output profile .....	III-17
III-2-7 Digital output profiles (Original Protocol) .....	III-21
III-2-8 Digital output profiles (MODBUS Protocol) .....	III-30
III-3. Principle of the ultrasonic flowmeter .....	III-37
III-3-1 Measurement Principle .....	III-37
III-3-2 Transmission and reflection methods .....	III-40
III-4. Appendix .....	III-41
III-4-1 Flow volume and average flow velocity.....	III-41
III-4-2 Pipe conditions and required straight length.....	III-42
III-4-3 Sound velocity & kinematics viscosity reference list .....	III-43
III-5. FAQ .....	III-45
III-5-1. Measured method .....	III-45
III-5-2. Measured fluids .....	III-47
III-5-3. Pipes .....	III-48
III-5-4. Installation location.....	III-49
III-5-5. Other.....	III-52
III-6. Trouble shooting .....	III-53
III-6-1. Main flowmeter unit and components.....	III-53
III-6-2. Measurement.....	III-54



# I. Installation

## Chapter I Index

### I-1. Configuration

Configuration .....	I-3
Basic Configuration (for large pipe 1 or 2path) .....	I-4
Basic Configuration (for large pipe 4path) .....	I-5
Basic Configuration (for small pipe 1 or 2path) .....	I-6
Basic Configuration (for small pipe 4path) .....	I-7

### I-2. Installation and Wiring

I-2-1 Setup Procedure .....	I-8
I-2-2 Selection of transducer setup position .....	I-10
I-2-3 Placement of the main unit .....	I-12
I-2-4 Wiring .....	I-12
- transducer cable	
- I/O (Analog output, Relay output) cable	
- power cable	
I-2-5 Multi-Path Connection to main unit.....	I-19
I-2-6 Functional ground connection .....	I-24
I-2-7 Installation of disconnection device for power line .....	I-24
I-2-8 Insulation for DC power source .....	I-24
I-2-9 Transducer Installation procedure .....	I-25
I-2-10 Transducer cable treatment for main unit .....	I-36
I-2-11 Cable connection treatment with chemical binder.....	I-39
I-2-12 Installation Outfit .....	I-41
I-2-13 Input parameters by Commissioning software.....	I-42

### I-1. Configuration

This Ultrasonic Flowmeter consists of the following primary components. Fig. 1-1 to 1-4 shows the interrelationship among the different parts.

No	Name	Q'ty	Details	Chap.	Page
1.	Main Unit	1pc	Ultrasonic Flowmeter Main Unit	III-2-5	III-14
2.	Transducers	2pcs (1pair)	Ultrasonic transmitter-receiver sensors (to be used in combination with cables)	III-2-5	III-15,16
3.	Mounting fixture	1set	Metal fixtures used to attach transducers to a pipe	III-2-5	III-15,16
4.	Coaxial cables	1pair	Used to connect the transducers to the main flowmeter unit	---	---
5.	Multi-Path Junction Box	1pc	Junction Box for 4 path measuring (Option)	---	---

**NOTE**

Q'ty of item 2,3,4 depends on its specification.

**Note:**

[ For AC power source ]

A switch or circuit-breaker shall be included in the building installation.

It shall be in close proximity to the equipment and within easy reach of the OPERATOR.

It shall be marked as the disconnecting device for the equipment.

[ For DC power source ]

The DC power source must be separated from mains by means of reinforced insulation.

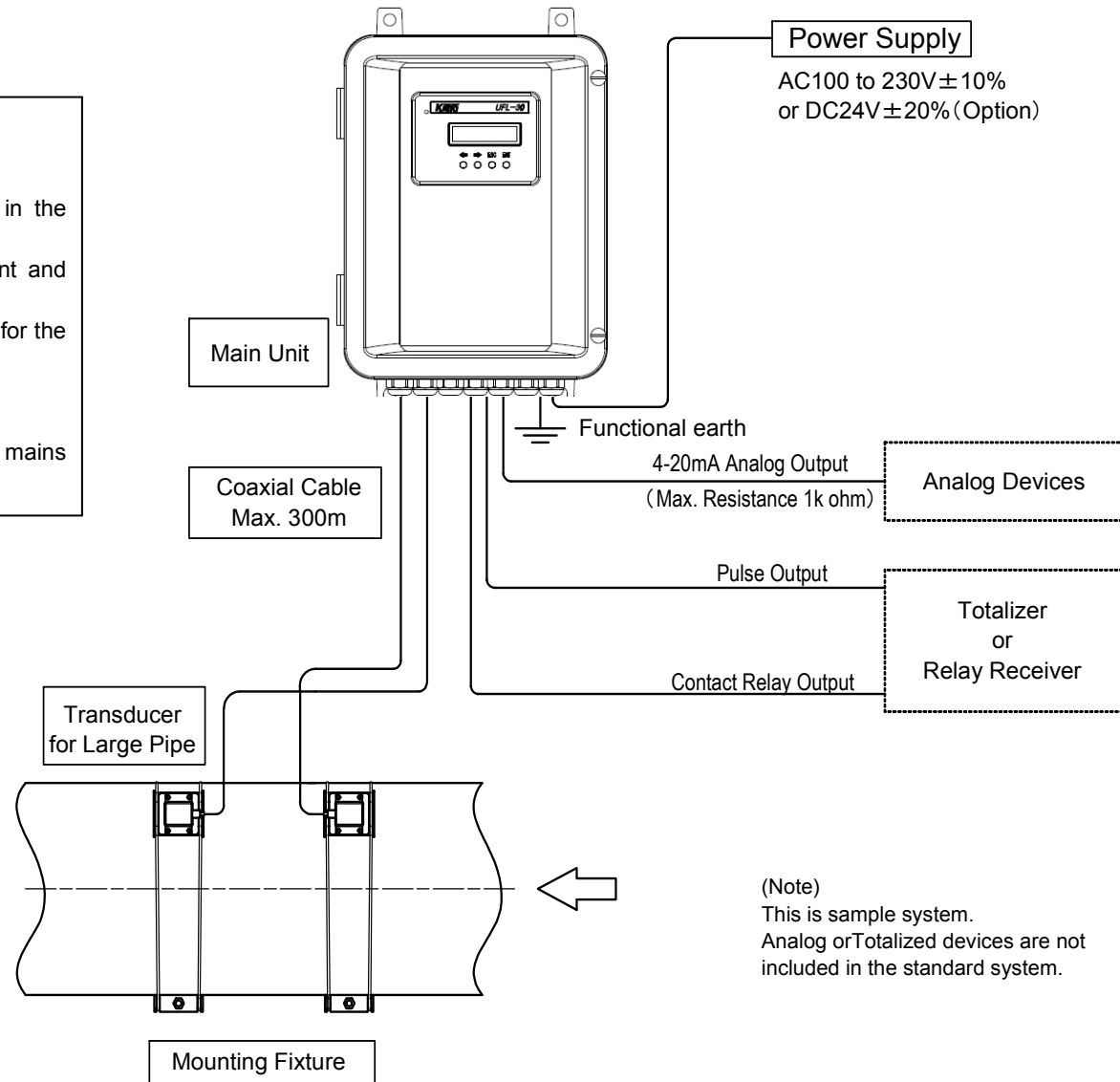
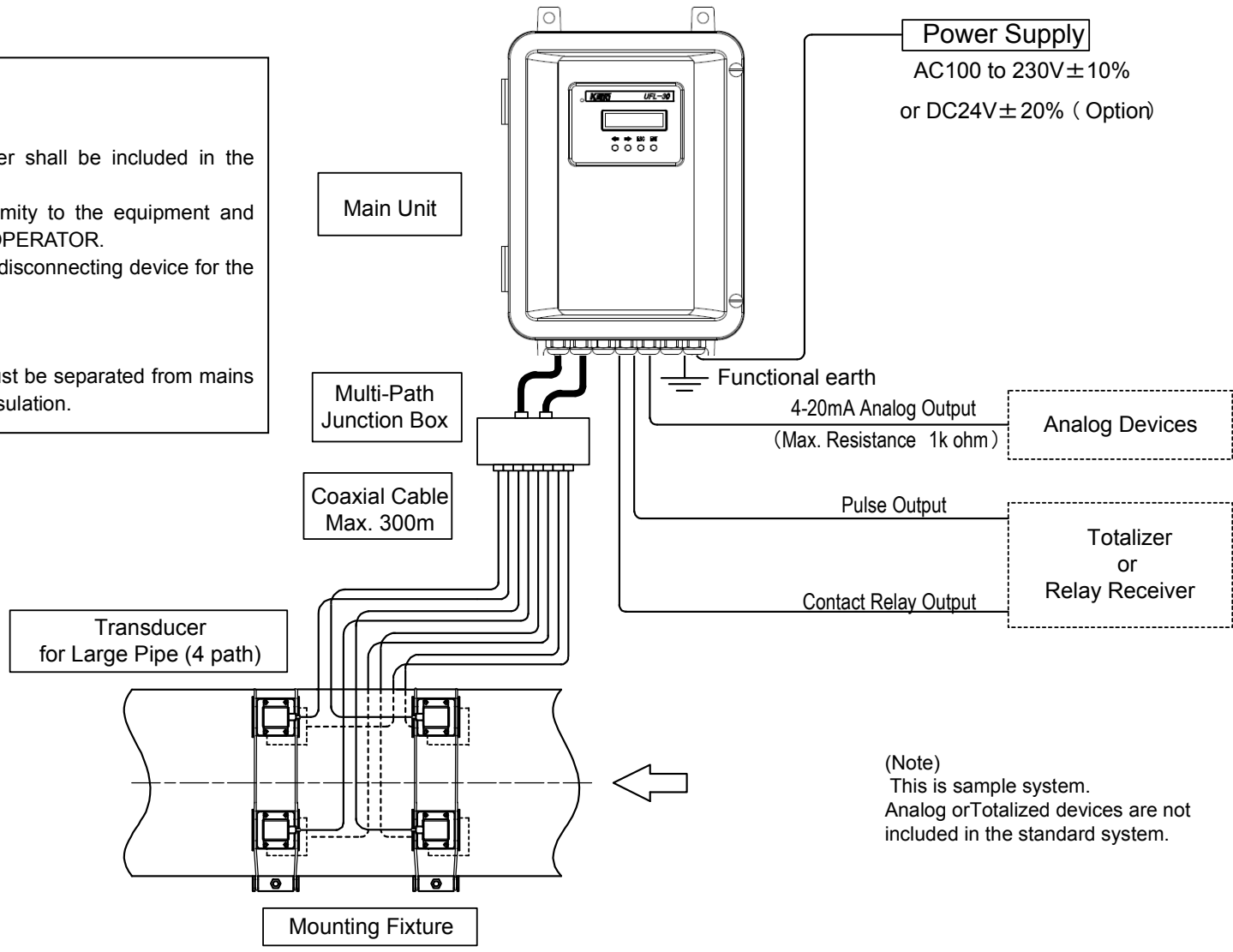

Fig 1-1; Ultrasonic Flowmeter basic system (1path or 2path)

**Note:**

[ For AC power source ]  
 A switch or circuit-breaker shall be included in the building installation.  
 It shall be in close proximity to the equipment and within easy reach of the OPERATOR.  
 It shall be marked as the disconnecting device for the equipment.

[ For DC power source ]  
 The DC power source must be separated from mains by means of reinforced insulation.



(Note)  
 This is sample system.  
 Analog or Totalized devices are not included in the standard system.

Fig 1-2; Ultrasonic Flowmeter basic system (4path)



**Note:**

[ For AC power source ]  
 A switch or circuit-breaker shall be included in the building installation.  
 It shall be in close proximity to the equipment and within easy reach of the OPERATOR.  
 It shall be marked as the disconnecting device for the equipment.

[ For DC power source ]  
 The DC power source must be separated from mains by means of reinforced insulation.

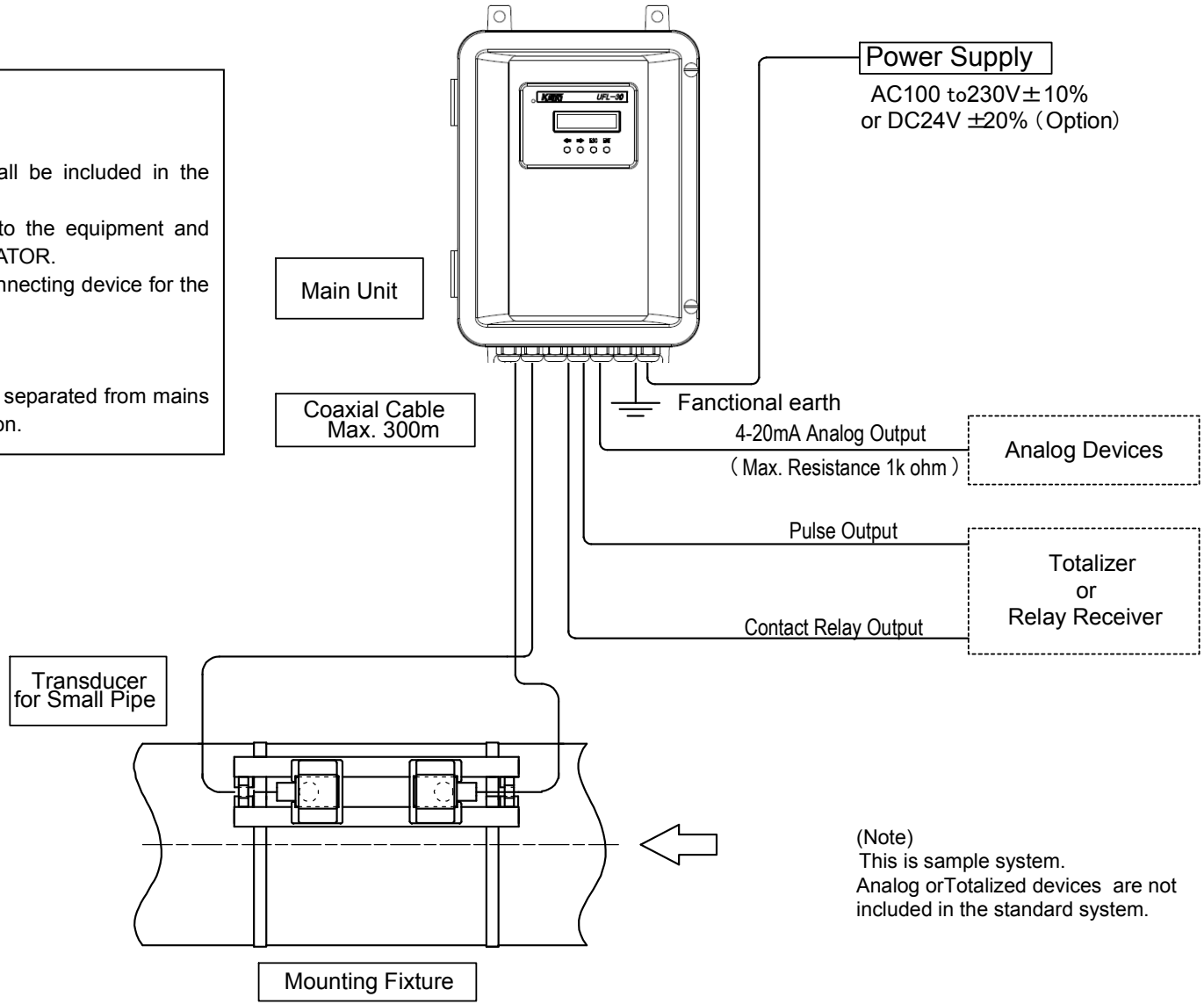

(Note)  
 This is sample system.  
 Analog or Totalized devices are not included in the standard system.

Fig 1-3; Ultrasonic Flowmeter basic system (1path or 2path)

**Note:**

[ For AC power source ]

A switch or circuit-breaker shall be included in the building installation.

It shall be in close proximity to the equipment and within easy reach of the OPERATOR.

It shall be marked as the disconnecting device for the equipment.

[ For DC power source ]

The DC power source must be separated from mains by means of reinforced insulation.

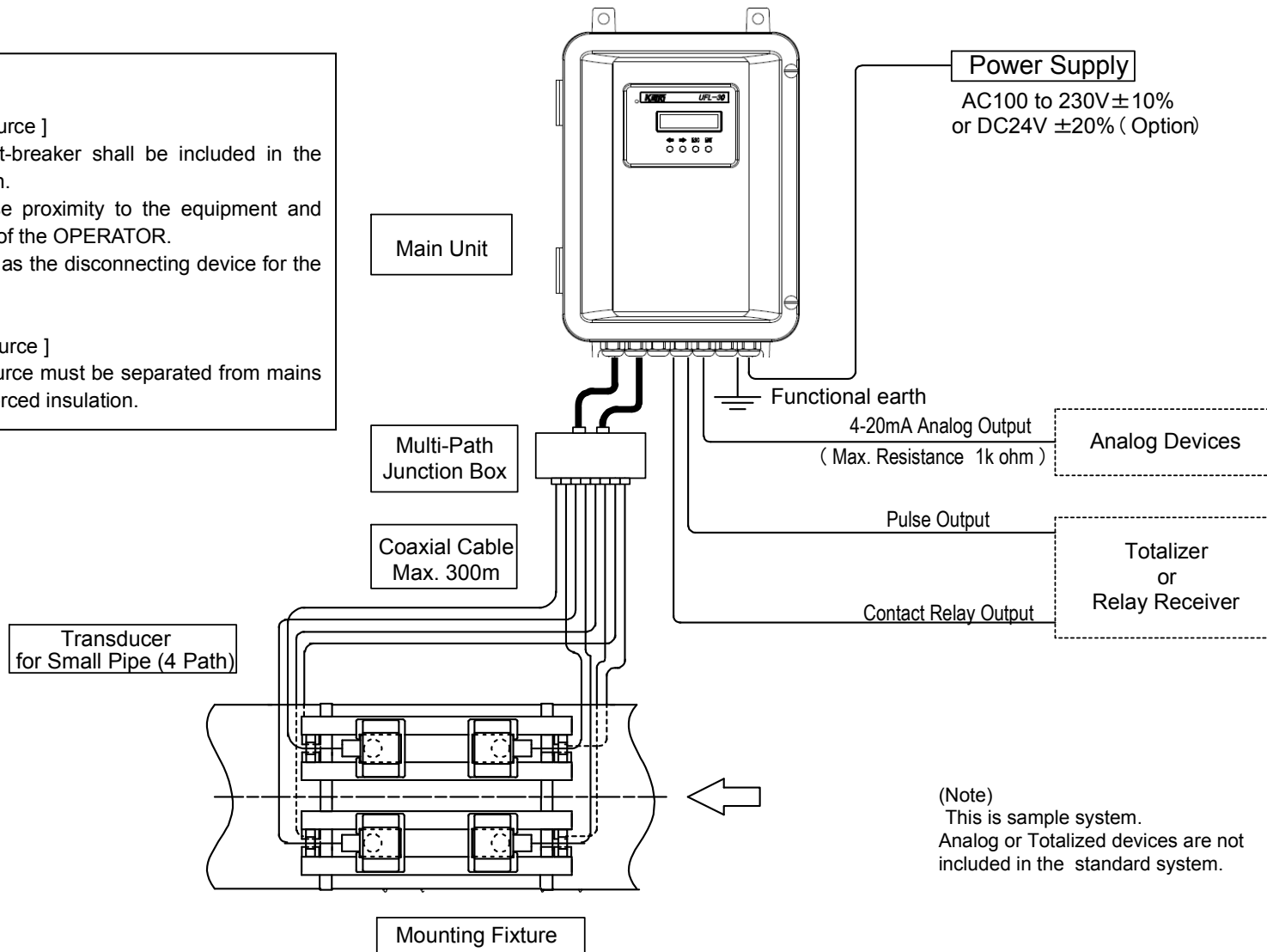



I-7

Fig 1-4 ; Ultrasonic Flowmeter basic system (4Path)

## I-2 Installation and Wiring

Installation and wiring should be worked carefully.

 <b>DANGER</b>
Be sure to stop power supply to the main unit for installation and wiring work to prevent electrical shock .
 <b>WARNING</b>
Make sure that wiring are made correctly as incorrect connections may result in damage to the main unit and connected accessories. Do not install or use the equipment in a atmosphere where any flammable or explosive gas is present.
 <b>CAUTION</b>
After installation and wiring work, tighten the front cover screws and cable glands of the main unit exactly to protect against water and dust.

### I-2-1. Setup Procedure

#### (1) Procedure

The basic steps in setting up the flowmeter system are outlined below.

Please note some limitations placed on operation from LCD.

No.	Step	Procedure	Reference Chapter	From PC	From LCD
1	Selection of transducer position		I-2-2	-----	-----
2	Installation Main Unit	Placement & Wiring connection	I-2-3 to 8	-----	-----
3	Transducer Parameter Input	(1) Unit System Selection	I-2-13 (8)	Yes	N/A
		(2) Q'ty of measuring path	I-2-13 (8)		
		(3) Pipe information input	I-2-13 (9)		
		(4) Transducer type	I-2-13 (9)		
		(5) Cable length	I-2-13 (9)		
		(6) Fluid parameter input	I-2-13 (9)		
4	Transducer distance confirmation		I-2-13 (11)	Yes	N/A
5	Output Setup	(1) Flow rate unit settings	I-2-13 (12) II-2-6 (2) a	Yes	Yes
		(2) Totalized output settings	I-2-13 (12) II-2-6 (4)	Yes	Yes
		(3) Analog output settings	I-2-13 (13) II-2-6 (3)	Yes	Yes
		(4) Alarm setting	I-2-13 (14) II-2-6 (3)	Yes	Yes
		(5) Contact output settings	I-2-13 (15) II-2-6 (5)	Yes	Yes
		(6) Digital output settings	I-2-13 (16) II-2-6 (6)	Yes	N/A
		(7) Upload parameters	I-2-13 (17)	Yes	N/A
6	Transducer Installation	Temporary installation by using grease. Transducer distance parameter required.	I-2-9	-----	-----
7	Cable Treatment		I-2-10 & 11	-----	-----
8	Wiring Connection to Main Unit		I-2-4 to 7	-----	-----
9	AGA settings	Pipe should be fulfilled with fluid.	I-2-13 (18)	Yes	Yes
10	Transducer Installation (Final)	Permanent Installation by Adhesive.	I-2-9	-----	-----
11	Finalizing Setup through PC configuration software or LCD	(1) AGA settings (Pipe should be fulfilled with fluid.)	I-2-13 (19)	Yes	Yes

(2) Required tool for installation

Following tools are required for installation site work.

No.	Item Name	Q'ty	Purpose
(1)	Monkey wrench (approx. 300mm)	2 pcs	For tightener handling
(2)	Second-cut file (approx. 300mm)	2pcs	For pipe or cable treatment
(3)	Hammer	1 pc	For wire or tightener location adjustment
(4)	Disc sander	1 pc	For pipe polish (Pipe treatment)
(5)	Cold chisel (200mm~300mm)	1pc	For sputter remover
(6)	Knife (or Cutter)	1pc	For cable treatment
(7)	Punch (or Marker)	1pc	For making on mounting point of transducer
(8)	Screw driver + (Phillips type)#1 & #2	1pc	For Inner panel handling & wiring
(9)	Screw driver – (Slotted type)3.5mm	1pc	For wiring terminal lever operation
(10)	Nippers (125~150mm)	1pc	For cable treatment
(11)	Long-nose pliers (125~150mm)	1pc	
(12)	Crimp tool (AMP 22~16)	1pc	For cable end treatment of PE cable
(13)	Soldering gun	1pc	For cable binding treatment (If any)
(14)	Wrench	1set	For tightener handling
(15)	Tape measure (3~10m)	1pc	For Transducer distance verification
(16)	Miscellaneous		
	Electrical tape		For cable treatment
	Marker		
	Gauge Paper		For confirm vertical line for transducer position
	Thinner		For paint remover or degreasing
	Cotton waste		For cleaner
	Grease		For temporary installation of transducer
	Paint		For repaint for pipe

## I-2-2 Selection of Transducer Setup Position



### WARNING

Do not install the transducers in a atmosphere where any flammable or explosive gas is present.

#### (1) Setup position

As a rule, compliance with the conditions given below when positioning the transducers assures top performance of the flowmeter and keeps measurement aberrations due to flow quantity fluctuation at an absolute minimum.

- a. Install transducers in a position that is filled with fluid, even after flow has stopped.
- b. In general, refer to the information in **III-4-2 Pipe conditions and required straight pipe length** regarding minimum required straight pipe lengths for the upstream and downstream side when selecting a position.
- b. Select a position with minimum flow-obstruction. Contact the manufacturer if circumstances require positioning of a pump, valves, pipes with gradual width increment, merger pipe, etc. either at the upstream or downstream side.
- d. Consider the possibility of sedimentation at the bottom of the pipe and the presence of an air pocket at the top of the pipe (Fig. 1-2-2-1). Recommended place for transducers is at angle between  $45^\circ$  from the level. In addition, avoid flanges and welding areas and select a smooth portion of the pipe to install the transducers.

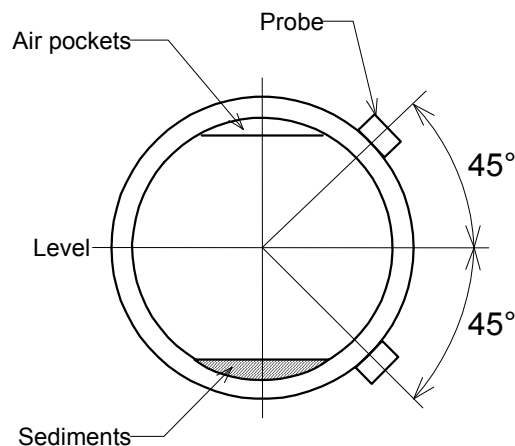

Fig. 1-2-2-1; Transducer Positioning

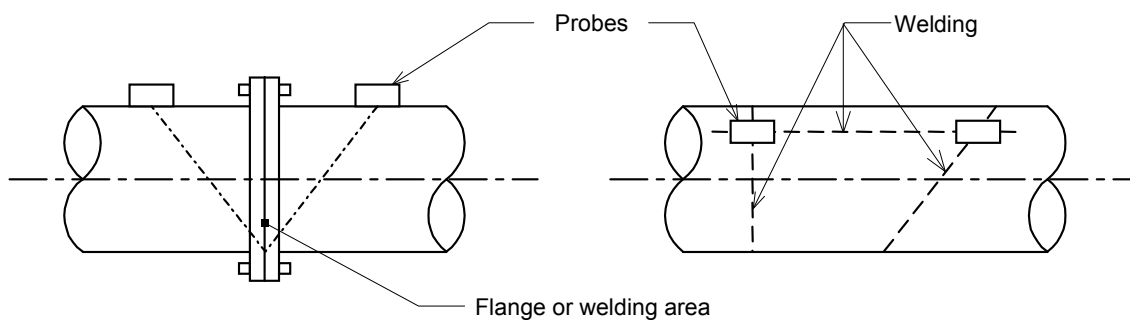
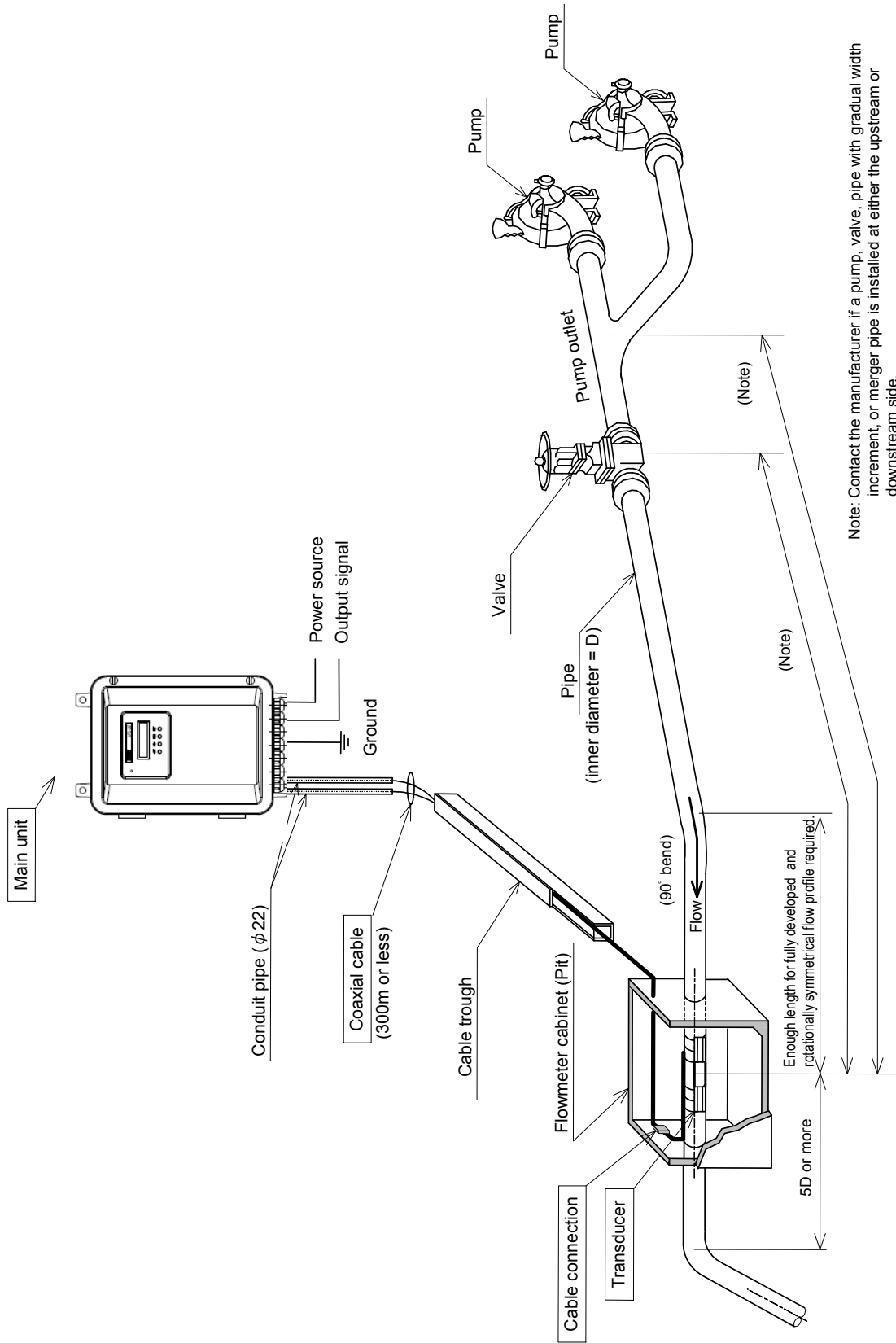

Fig. 1-2-2-2; Unsuitable Transducer Positions



Note: Contact the manufacturer if a pump, valve, pipe with gradual width increment, or merger pipe is installed at either the upstream or downstream side.

Fig. 1-2-2-3; Ultrasonic Flowmeter Positioning Example

### I-2-3 Placement of the main unit

<b>⚠ WARNING</b>
Do not install the main unit in a atmosphere where any flammable or explosive gas is present.
<b>NOTE</b>
Do not install the main unit higher than altitude 3000m to comply with EC directive.

- (1) Setup location
 

Consider the following conditions when selecting a setup location for the main unit.

  - a. Place the main unit in a location with an ambient temperature range of -10 to +60°C. Do not place the unit near a heating element and avoid exposure to direct sunlight.
  - b. Do not place the unit in an area with excessive dust and/or a corrosive atmosphere.
  - c. Place the unit in a location where inspections and maintenance duties can easily be performed.
  - d. Ensure that the length of the cable connecting the main unit with the transducers does not exceed 300m.
  - e. Do not place the unit in a location where interference through electrical devices and power lines could occur.
- (2) Main unit positioning
  - a. Use 4 bolts (M10 etc.) or similar fixtures to secure the main unit in a vertical position to a wall.
  - b. Secure the area around the unit to facilitate maintenance inspections.
- (3) Replace blind plug to cable gland
 

Place wiring q'ty of cable gland instead of attached blind plug.

### I-2-4 Wiring

<b>⚠ DANGER</b>
Be sure to stop power supply to the main unit while wiring work to prevent electrical shock .
<b>⚠ WARNING</b>
Make sure that wiring are made correctly as incorrect wiring may result in damage to the main unit and connected accessories. Refer specifications for each Input/Output in clause III-2-2.

- (1) Ensure that main power is turned off.
- (2) Make sure that the coaxial cables connecting the transducers to the main unit are kept apart from power lines and position the cables to avoid proximity to electrical appliances.
- (3) Refer to Fig. 1-2-4-1 to Fig. 1-2-4-3 and Table 2-1 for cable connections on the main unit and accessories.

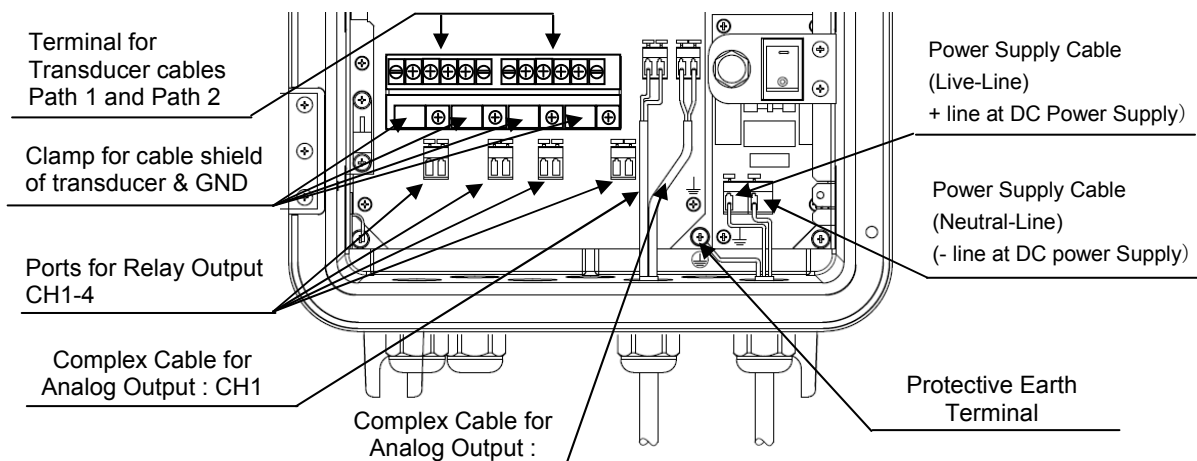

Fig.1-2-4-1. Connection to Main Unit

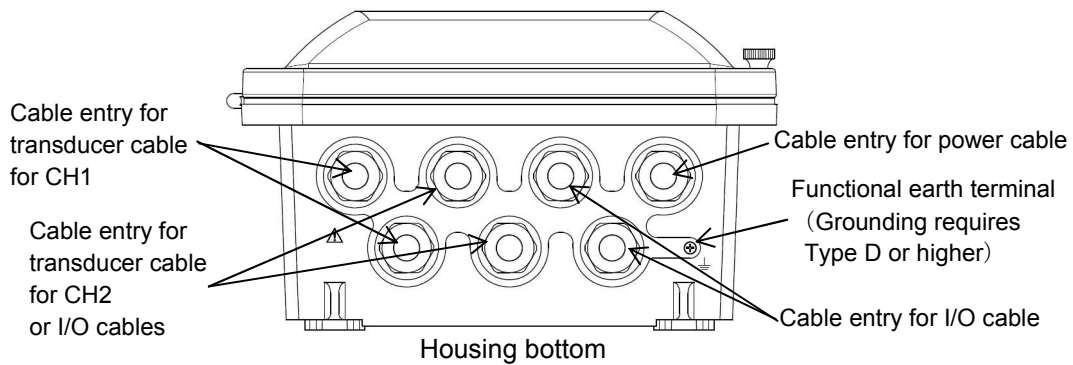

Fig 1-2-4-2. Wire Entry & Earth connector

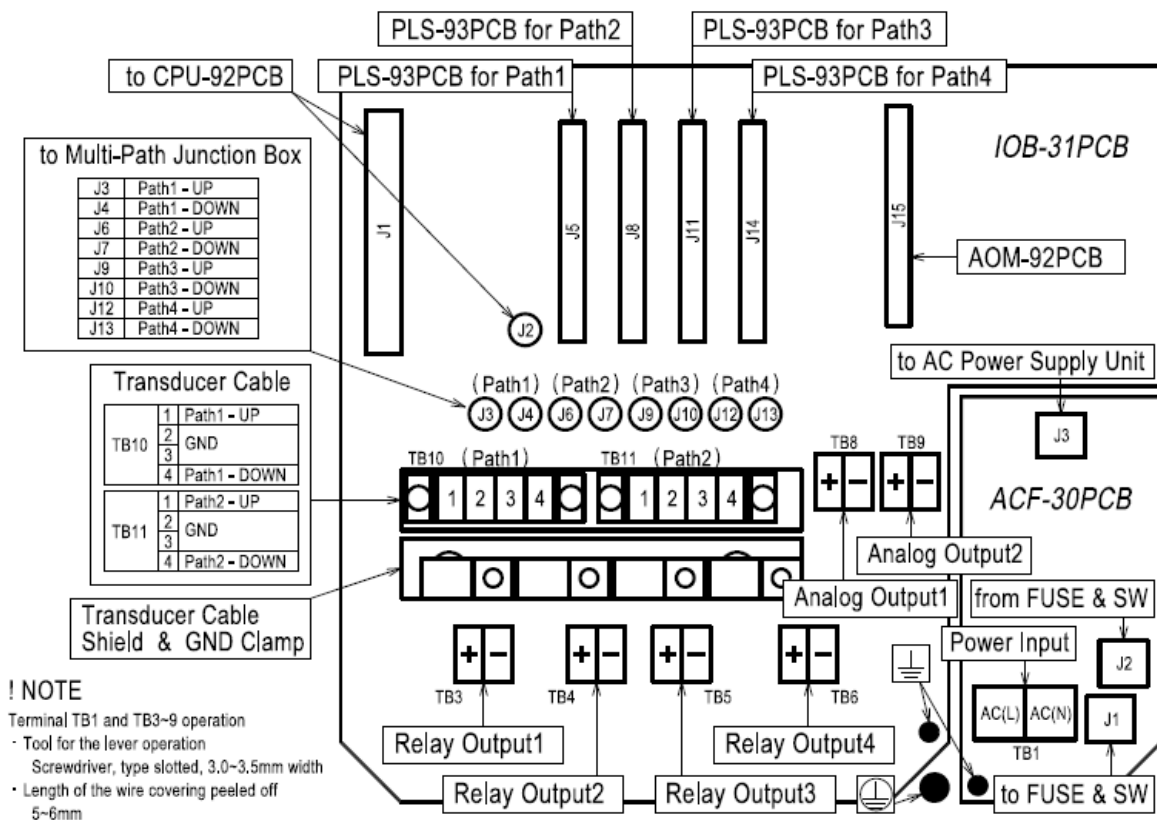

Fig 1-2-4-3. Internal Connection Terminal of Main Unit (AC Power)

**NOTE**

In case of DC power supply, **ACF-30 PCB** will be changed to **DCF-30 PCB**.

Connection will be as below.

AC(L) to be +DC  
 AC(N) to be -DC  
 PE to FE

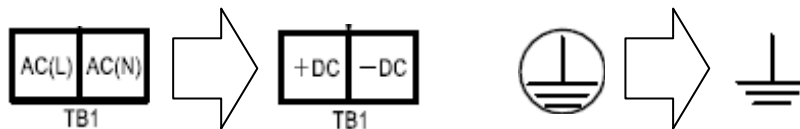

**NOTE**

Terminal TB1 and TB3-9 operation must be handled by screwdriver type slotted 3mm~3.5mm as tool for lever operation.

These terminals covers 5~6mm wire length as peeled off.



**Table 2-1; Connection Terminals**

Specification or settings may limit the functions.  
Please be careful of the polarization(+/-) of each line.

Name	Connection	Instruction		
Relay Output  CH1 CH2 CH3 CH4 (*1)	TB3 TB4 TB5 TB6	"+" is for positive-side and "-" is for negative-side of Voltage or current source.		
		<b>User can assign max 4 types of contact output from following selection.</b>		
		(1)BREAK: Not Used (Normal Open)		
		(2)MAKE: Not Used (Normal Close)		
		INTG PULSE : Totalizing Pulse output (3) FW INTG : One pulse for every totalizing unit of forward flow. (4) BW INTG : One pulse for every totalizing unit of backward flow. Output pulse width is selectable.		
		(5) ROFF: Receiving Echo Error Alarm (contact closes under alarm condition)		
		(6) B.D. : Break Down (unit failure) Alarm (contact closes under alarm condition)		
		(7) B.D.or ROFF : Contact closes under alarm condition (5) or (6)		
		LIMIT : High or Low limit alarm (8) HI-LMT : Contact closes when measuring value exceeds the limit (9) LO-LMT : Contact closes when measuring value falls below the limit Polarization is ignored for this limitation alarm.		
		DRCT : Direction output (10) FW-DRCT: Contact closes for Forward flow. (11) BW-DRCT : Contact closes for Backward flow.		
		RANGE : Analog Range selector output for double range output (12) HI-RNG : Contact closes for high range values. (13) LO-RNG : Contact closes for low range values.		
		ANALOG OUT 1, 2	TB8 TB9	Analog Output "1+" and "1-" mean channel 1. "2+" and "2-" mean channel 2. "+" is current source side and "-" is current sink side.
		Power Source (*2)	TB1	When main unit type is for AC Power supply, "N" should be connected to Neutral-line and "L" should be connected to Live-line. When main unit type is for DC Power supply, "+" should be connected to Positive-line and "-" should be connected to Negative-line.
Protective Earth	PE terminal	PE terminal .should be connected to earth of power source.		
Path-1 UP DN	TB10-(1 ) TB10-(4)	Connect upstream transducers to "UP" side. Connect to downstream transducers to "DN" side. Connection to primary path Transducers when 2 path measurement. (*3)		
Path-2 UP DN	TB11-(1 ) TB11-(4)	Connection to secondary path Transducers when 2 path measurement. (*3) Connect upstream transducers to "UP" side. Connect to downstream transducers to "DN" side.		
Multi-path Junction box (*4)	Path1: J3/J4 Path2: J6/J7 Path3: J9/J10 Path4: J12/J13	Cables from Multi-path junction box are connected to them. Multi-path junction box (option) is used for transducer connection when 4 path measurement.		
DIGITAL 1,2 (*5)	RJ-45	RS232C output.		

(\*1) Independent settings are provided for contact outputs of each channel (CH1-CH4).

Please refer to details in "Chapter II-1 Function" and "Chapter II-2 Operation"

(\*2) Type of AC or DC power supply can be selected before shipment.

Specified cable should be used for power cable to comply with EC directive.

(\*3) 2 path measurement system is an option.

(\*4) 4 path measurement system involves special connection. 4-path measurement is an option.

(\*5) Length of DIGITAL output cable should be less than 3 m long to comply with EC directive.

(4) Connect transducer cables

Connect the coaxial cable for the upstream transducer to a Terminal for transducer. Likewise connect the cable for the downstream transducer to a same terminal. For Multi-path measurement connection, please refer to I-2-5.

For the transducer cable treatment, refer to clause I-2-10.

aa. Remove the sensor terminal cover and the cable clamps for ch1-UP and ch1-DOWN of Path-1.

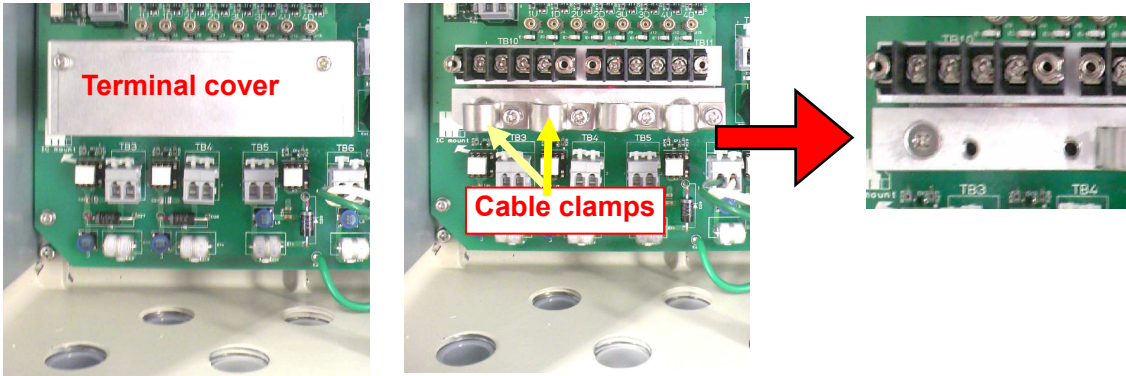

bb. Loosen the screw on both sides of the sensor cable terminal "TB10" by a screwdriver. (Two screws at center should not be used. They are connected to the signal ground.) Pass the "UP" sensor coaxial cable through the cable gland of upper left.

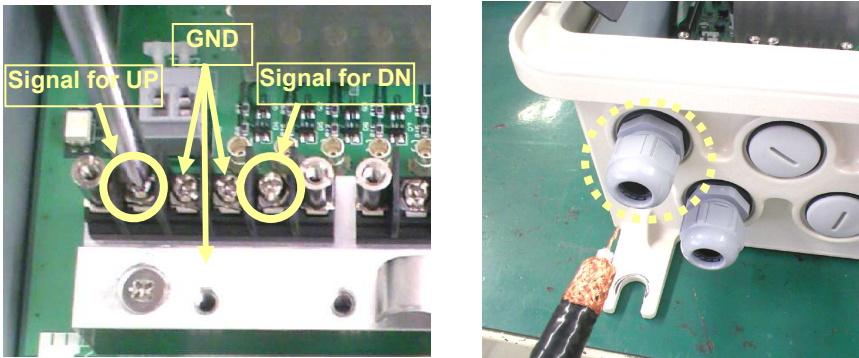

cc. Put GND part of the cable on the clamp stand and pass the core conductor of the coaxial cable under the board spring of the screw.

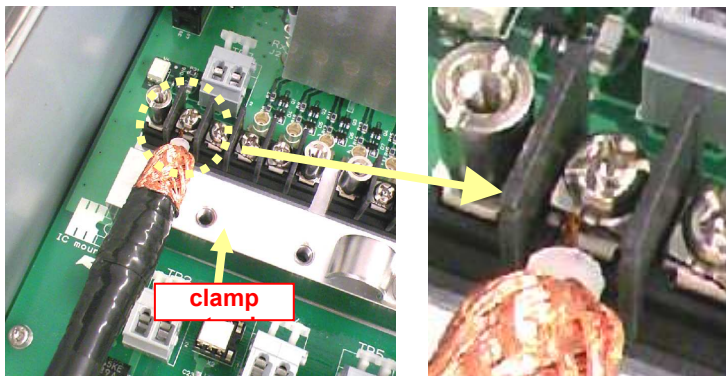

dd. Hold down the GND part of the coaxial cable by the cable clamp and tighten up the screw firmly. After that, tighten up the screw of the terminal "TB10" without so strong. Note that this turn of work is important. When the wrong order, work to clamp GND maybe give a stress to the core conductor of the cable and cut it.

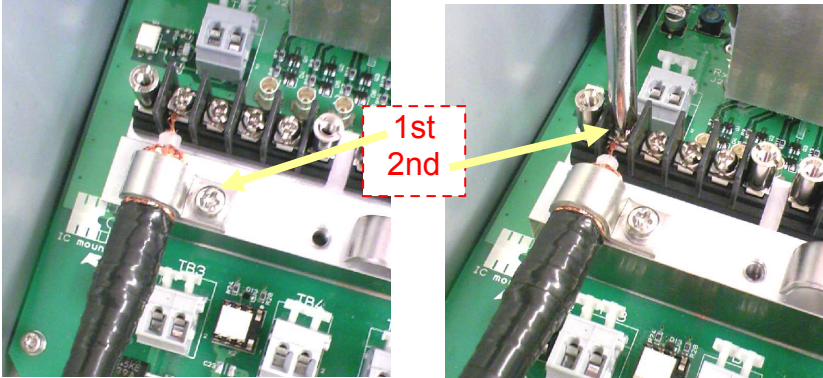

ee. The "DOWN" sensor coaxial cable is similarly processed from aa to dd.

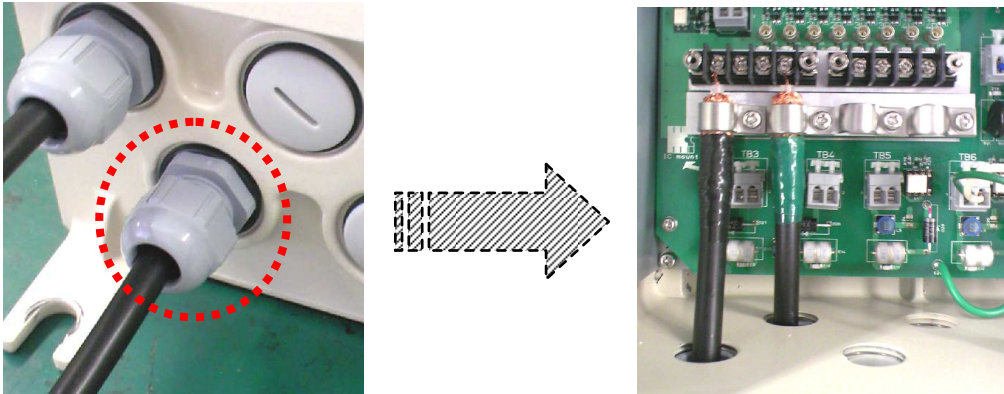

ff. Close the terminal cover.

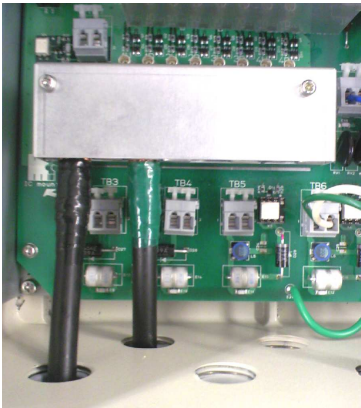

gg. Finally, tighten the cable gland exactly to fix the cable and to protect against water and dust. (Torque : Approx. 1.5 N m)

(5) Connect I/O cable (analog or relay output) line  
 Use high quality standard issue cables with a cross-section of 0.75 - 2 mm<sup>2</sup> as signal cables which outer size of cable is 6~12mm as completed treatment.

aa. Pass the I/O cable through the cable gland of upper second from right. After positioning the cable, tighten the cable gland exactly to fix the cable and to protect against water and dust .  
 (Torque : Approx. 1.5 N m)

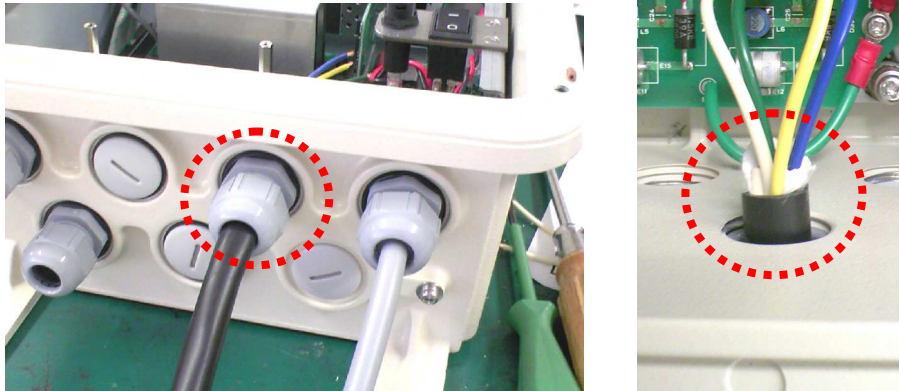

bb. Insert each wire in the loading slot while pushing the lever of the terminal TB6 and TB8 by the screwdriver, type slotted.  
 Sample of connection Analog output CH1 and Relay output CH4 are shown below.

Analog output (A-OUT)

Positive-line ----> #1 slot of TB8  
 Negative-line ----> #2 slot of TB8



Relay output

Positive-line ----> #1 slot of TB6  
 Negative-line ----> #2 slot of TB6

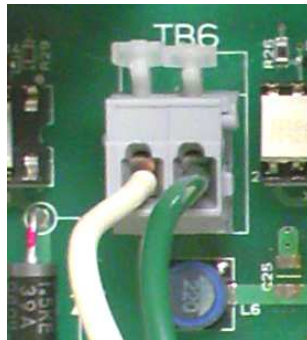

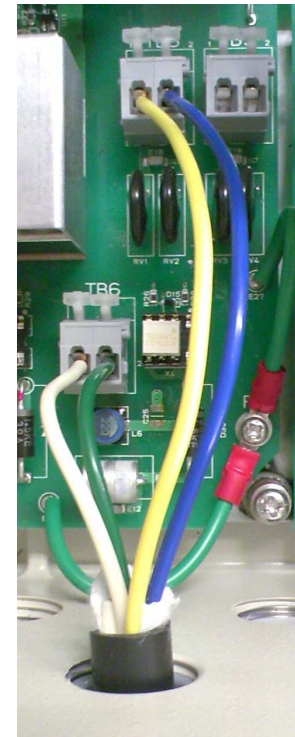

Finish



**⚠ CAUTION**  
 Check conformity for the polarity of terminal and wire and for rating of connected device. It may be that wrong wiring or wrong rating will break the equipment.

(6) Connect Power cable

 <b>DANGER</b>
Be sure to stop power supply to power cable while wiring work to prevent electrical shock .
 <b>CAUTION</b>
1. Avoid sharing a power source with other electrical appliances. 2. The cable for power source connection should be used as follows to comply with EC directive. Model name : OLFLEX Classic 100 multi-conductor, flexible power and control cable Part number : 10060 Manufacturer : LAPP KABEL Specification : 3 conductors AWG16, 1.5 mm <sup>2</sup> nominal outer diameter 8.1 mm

- aa. Pass the power cable through the cable gland of upper right.
- bb. Peel off the covering of the cable end by 60mm and peel off the covering of each electric wire.
- cc. After positioning the cable, tighten the cable gland exactly to fix the cable and to protect against water and dust . (Torque : Approx. 1.5 N m)

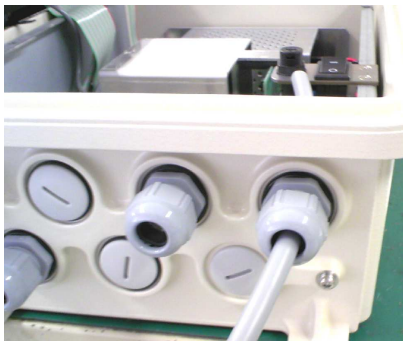

Photo for aa

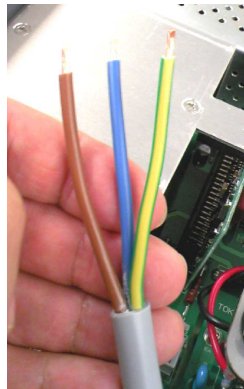

Photo for bb

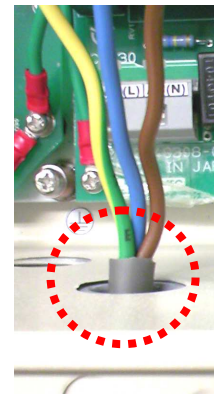
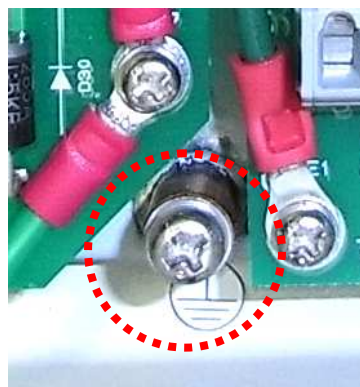

Photo for cc

**NOTE**

To avoid over stress onto terminals, fix cable by tightened cable gland.

- dd. Crimp M4 size solderless ring terminal with insulator to protective earth conductor of power cable tightly. Then, fix the terminal onto PE terminal of the equipment.



ee. Insert each wire in the loading slot while pushing the lever of the terminal by the screwdriver, type slotted. Then finished.

AC type

Live-line -----> #1 slot of TB1  
Neutral-line -----> #2 slot of TB1

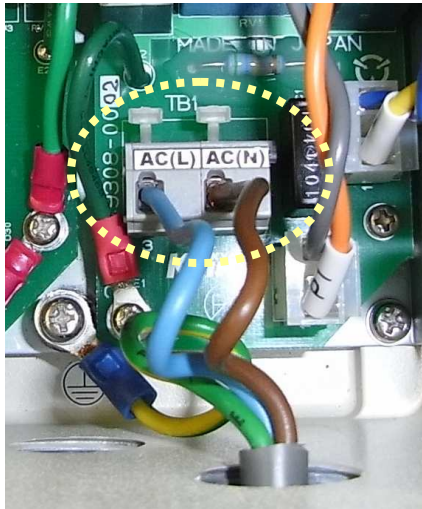

DC type

Positive-line -----> #1 slot of TB1  
Negative-line -----> #2 slot of TB1

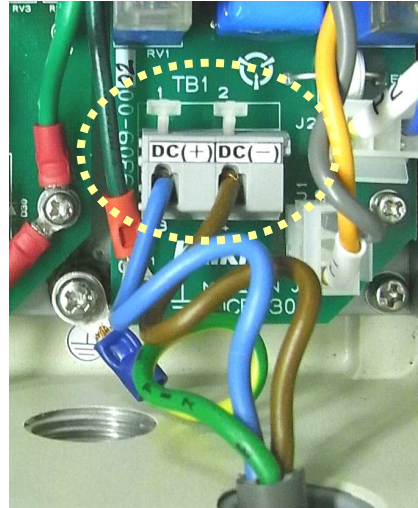

**I-2-5 Multi-Path Connection to Main Unit**

**(1) 2-Path Connection (If ordered as 2-path system, skip to 1-D.)**

1-A. Pulser module

One (1) module is preset in slot "CH1".  
For 2-path measurement, one (1) extra pulser module is required.  
This module is set on the mother board in the second slot "CH2".

1-B. Module insertion

In order to insert the extra module, the module cover must first be removed by loosening the screws.  
Insert module, paying attention to the orientation of the board.

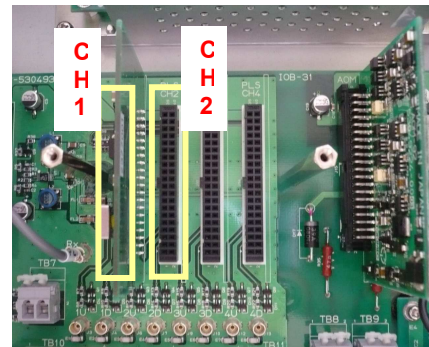

Photo for 1-A

**⚠ CAUTION**

Pulser Module may be defected by static electricity of your hand. Discharge it prior to touch the module.

1-C. Replace module cover

Replace module cover after insertion of the extra pulser module.



Photo for 1-C

1-D. CH-2 transducer connection

A second transducer line can be connected to terminal for CH2 after cable preparation.

**(2) 4-Path Connection (If ordered as 4-path system, skip to 2-E)**

2-A. Remove the shield cover of transducer cable terminal

Remove the shield cover (indicated below) for multi-path set up (bottom diagram) by loosening the screws.

In case of ordered as 4-path system originally, shield cover and clamp stand are not included.

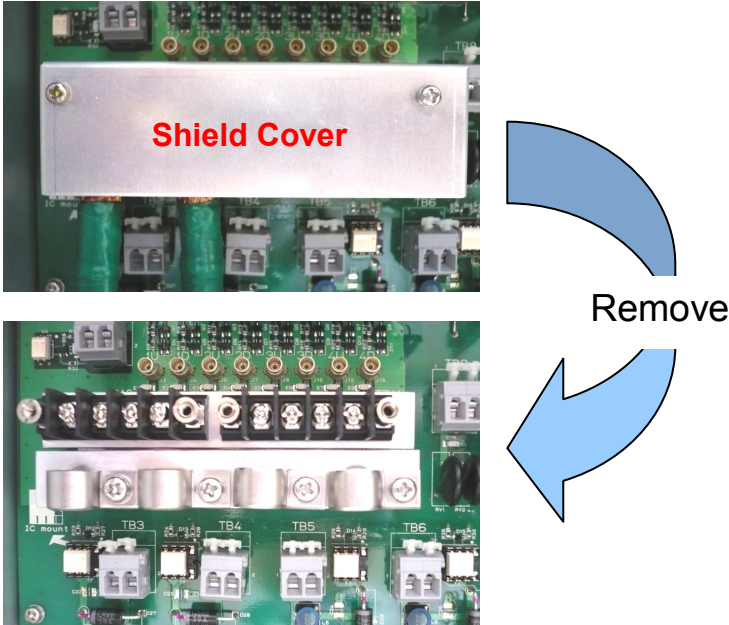

2-B. Pulser Module

With 1 or 2 modules already in slot CH1 (and CH2), extra pulser modules are required for 4-path measurement. (CH1 to CH4)

These modules should be set on the mother board next to the fourth slot .

2-C. Module Insertion

In order to insert the extra modules, the module cover must first be removed by loosening the screws. Insert modules, paying attention to the orientation of the board.

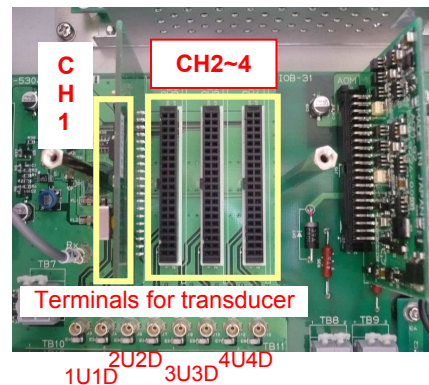



Photo for 2-B

 <b>CAUTION</b>
Pulser Module may be defected by static electricity of your hand. Discharge it prior to touch the module.

2-D. Replace module cover

Replace module cover after insertion of the extra modules.

2-E. Check Terminals for transducer line

One "multi-path junction box" is required for 4-path measurement.

Connection should be made to the terminals for transducer connectors as shown in Photo 2 through the inlet grommet. Final installation image is as below.

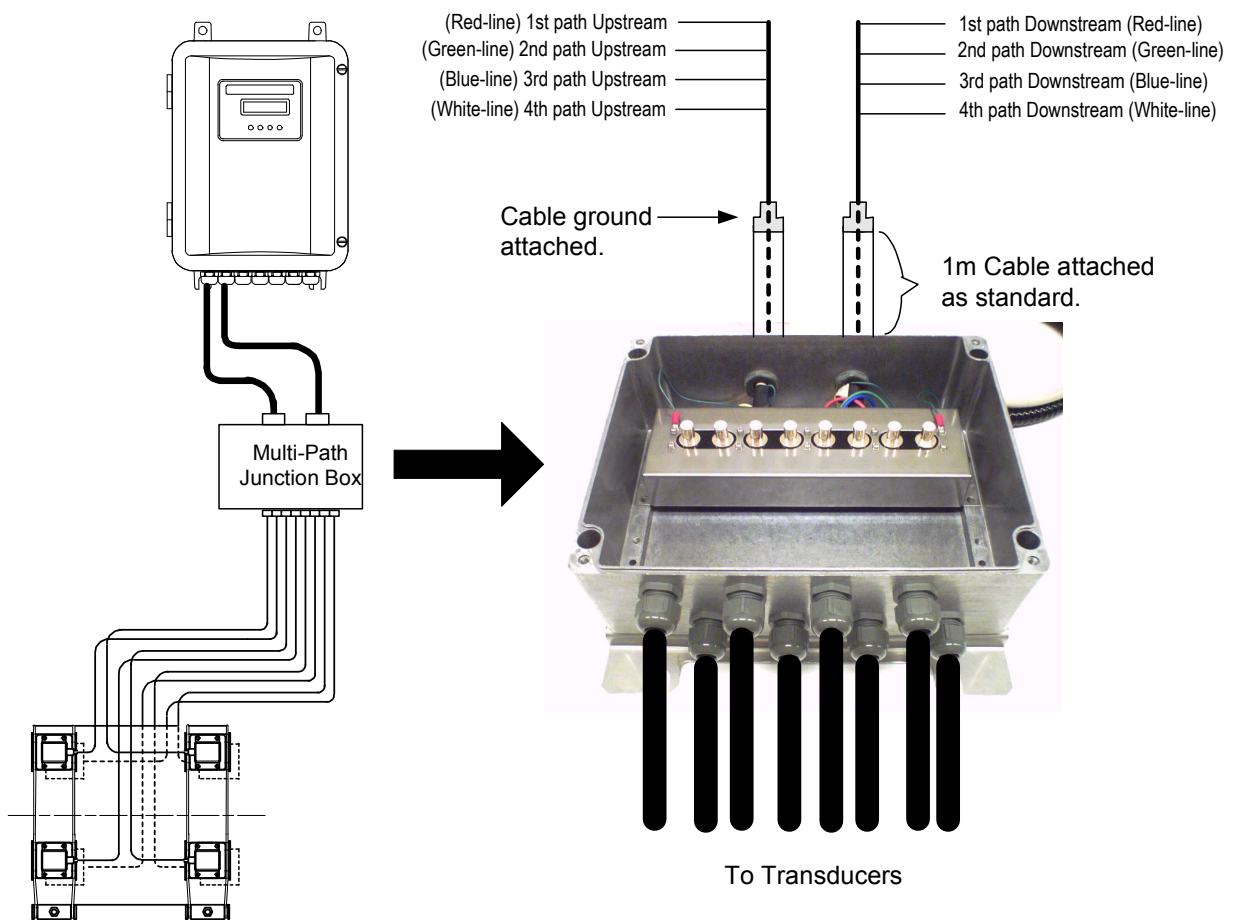

## 2-F. Multi-path junction box installation

The multi-path junction box should be installed near the main unit. The junction box is supplied with 1m cables + mounted special coaxial connectors for connection to the main unit.

## 2-G. Assemble cable conduit

### 1) Components

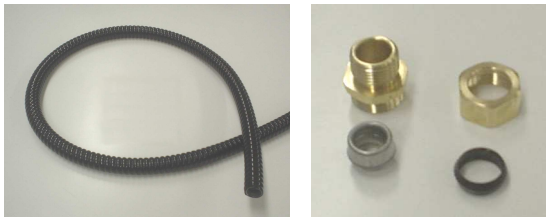
Cable fitting x 4pcs Attached on Junction Box side, 2 pcs provided.	Cable Conduit x 2pcs Fitting Parts x 4pcs
 <p data-bbox="236 1910 774 1968">Assembly is comprised of several parts as shown in the above photo.</p>	



## 2) Assembling cable conduit

Step1: Prepare parts in order shown below



Step2: Assemble as shown



Please follow the above procedure for both conduit sides.

## 2-H. Lead cable into Conduit

Step1: Lead cable



Step2: Fix bolt



Step3: Slip on other cable parts

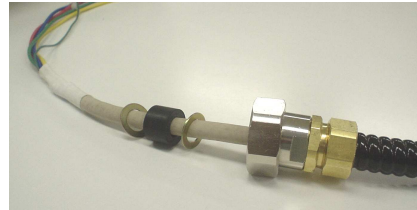

## 2-I. Attach conduit fittings

Screw cable fittings onto the main unit. At this time, keep the fittings on the multi-path junction box side loose as shown in the right photo.

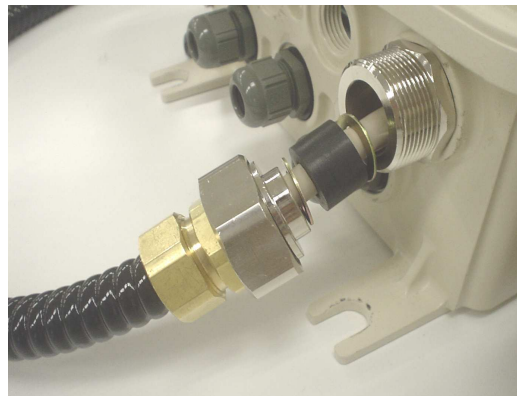
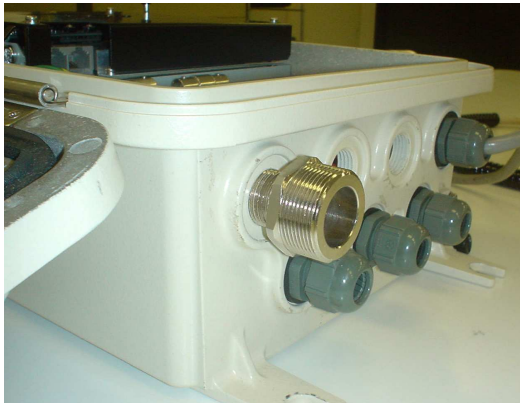

## 2-J. Adjust cable length

Step1: Lead cables into the main unit.



Step2: Pull surplus cable from the junction box side and adjust cable length so about 2cm extends inside of the main unit.

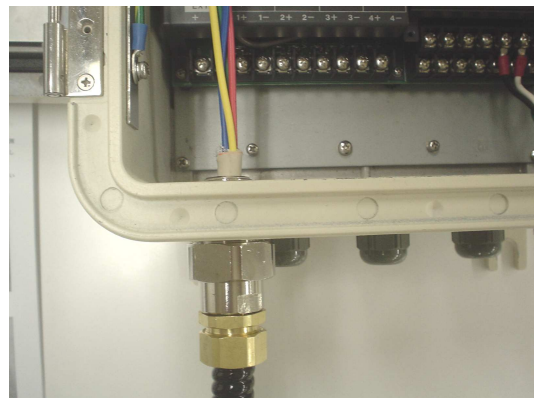

Step3: Fix cable gland on main unit.  
as shown below.



Step4: Fix cable gland on junction box  
side as shown below.



2-K. Connection of Transducer lines from junction box to terminals of main unit  
Connect the 8 transducer lines to the main unit. Each line is color-coded. Connect lines to their proper terminals.

1U = 1<sup>st</sup> path upstream side  
2U = 2<sup>nd</sup> path upstream side  
3U = 3<sup>rd</sup> path upstream side  
4U = 4<sup>th</sup> path upstream side

1D = 1<sup>st</sup> path downstream side  
2D = 2<sup>nd</sup> path downstream side  
3D = 3<sup>rd</sup> path downstream side  
4D = 4<sup>th</sup> path downstream side

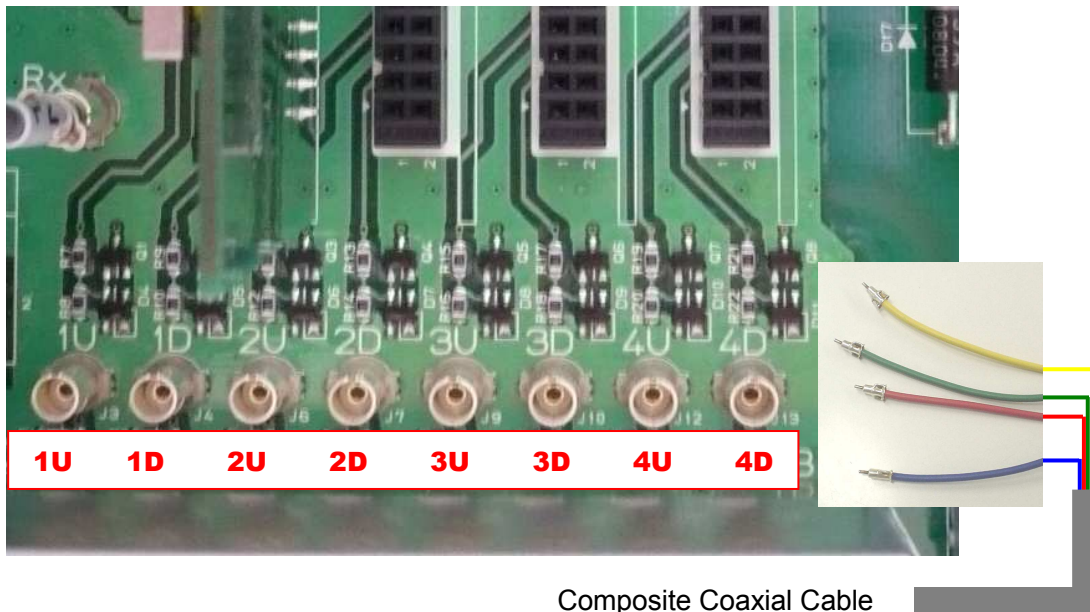

2-L. Transducer line connection to junction box  
After installing junction box near to the main unit, connect transducer lines to the junction box.

**⚠ CAUTION**

After installation and wiring work, tighten the cable glands exactly to protect against water and dust.

### I-2-6 Functional ground connection

System should be grounded as near to the main unit as possible based on the grounding specifications in (\*1). Refer to Fig.1-2-4-2 for functional ground connection points.  
Functional grounding would be worked for noise shield and lightning surge protection.

(*1) Grounding
Grounding resister: Less than 100 ohm
Applicable grounding material: Steel Frame & Metal Exterior for low voltage (less than 300V)
Thickness of grounding cable: Diameter more than 1.6mm <sup>2</sup> (Soft-copper wire)

### I-2-7 Installation of disconnection device for power line



#### **DANGER**

Be sure to stop power supply while installation of the device to prevent electrical shock .

This flowmeter does not have a disconnection device which meets the relevant requirements of IEC 60947-1 and IEC 60947-3 for power line. Therefore, install a switch or circuit-breaker as the means for disconnection of power line for AC power type of main unit to comply with EC directive.

It is specified as follows,

- a) a switch or circuit-breaker shall be included in the building installation;
- b) it shall be in close proximity to the equipment and within easy reach of the OPERATOR;
- c) it shall be marked as the disconnecting device for the equipment.

#### **NOTE**

Required ratings for the flowmeter are 2A rated current and 250V rated voltage.

### I-2-8 Insulation for DC power source

The DC power source must be separated from mains by means of reinforced insulation for DC power type of main unit to comply with EC directive.

## I-2-9. Transducer Installation Procedure



### CAUTION

Do not give a shock to the transducer.

The distance between transducers needs to be determined prior to transducer installation. Please refer to section I-2-13 to determine this distance before proceeding with the steps described below for installation

### (1) Transducer Installation on Pipes Greater than 300mm in diameter

There are two transducer installation methods. One is the reflection method and the other is the transmission method. Generally, the reflection method is applied to small pipe (less than 500mm) while the transmission method is used for larger diameter pipes. However the method to be chosen may also depend on signal strength based on the pipe material and/or flow conditions.

#### 1-A. Reflection Method (V-method)

1-a-1. Wrap gauge paper around the pipe where you intend to make the flow measurement as shown in Fig.1-2-9-1. Make sure the paper is long enough to overlap and that the overlapping edge is square. Gauge paper may be ordered and included in the standard installation kit.

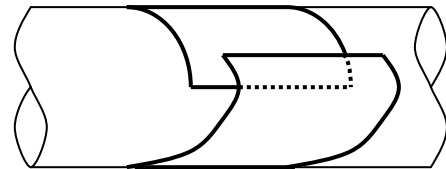

Fig. 1-2-9-1

1-a-2. Mark the pipe on either side of the paper where it overlaps (points "A" in Fig. 1-2-9-2).

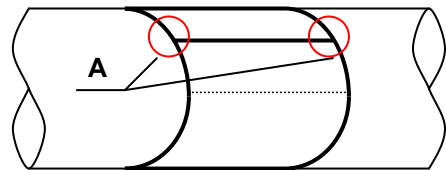

Fig. 1-2-9-2

1-a-3. Remove the paper from the pipe. Fold the paper in half, aligning the mark with the square edge of the paper. Crease and mark along the fold. Alternately, you can measure half the distance between the mark and the squared end and draw a line. In paper has been previously similarly marked, skip to step a-5.

Measure and confirm the circumference of the pipe.

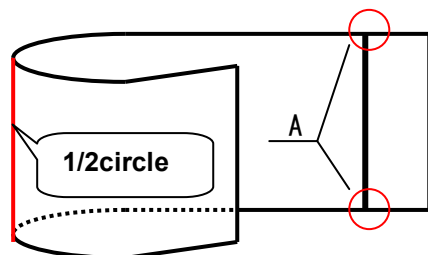
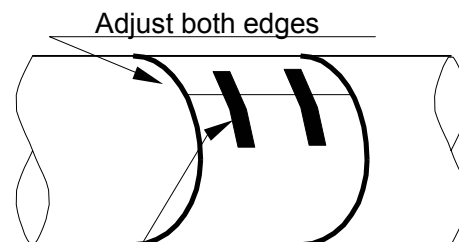

Fig. 1-2-9-3

1-a-4. Rewrap the paper around the pipe at the intended flow measure point.



Fix gauge paper using adhesive tape

Fig. 1-2-9-4

1-a-5. Using a pencil or marking pen, extend the crease lines outward from each edge of the paper onto the pipe (at points (1),(2)). With the outside edge of one holder (i.e. edge for P-distance measurement) which is to be positioned at one edge of the gauge paper, measure and mark off the P-distance to the other transducer holder as shown in Fig. 1-2-9-6. After marking, remove the gauge paper.

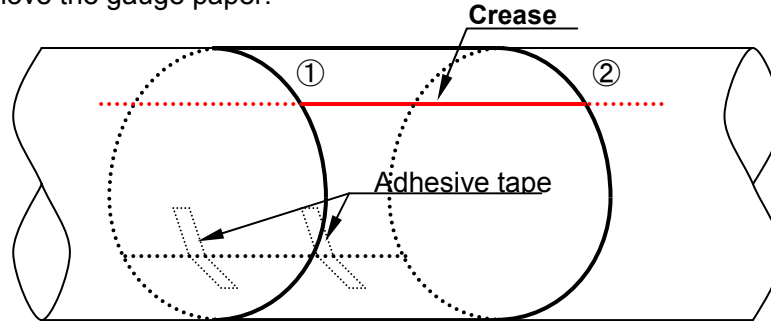

Fig. 1-2-9-5

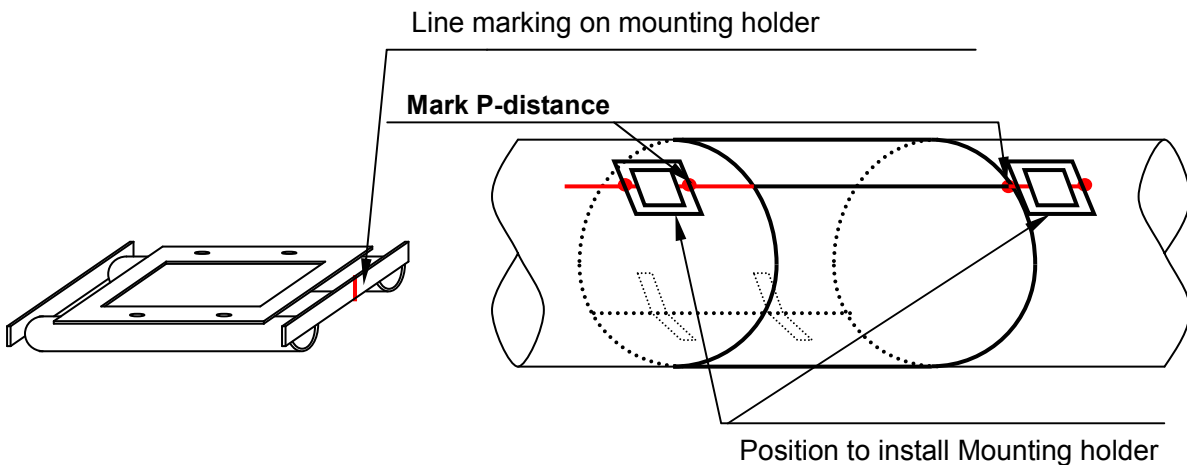

Fig. 1-2-9-6

1-a-6. Position the transducer-mounting holders on the pipe and align in accordance with the lines marked on the pipe.

Mark the 'P-distance' (distance between the opposing outside edges of the two holders). The calculated distance between the two transducers is the fitting distance ('F-dist') which is the distance between the opposing inside edges of the transducers and which depends on the transducer type, pipe parameters and fluid type.

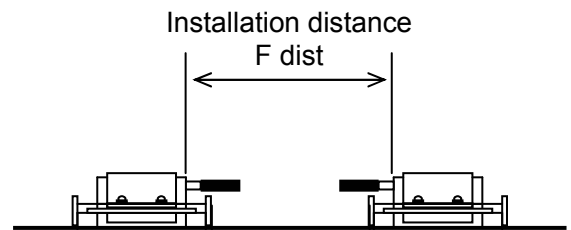

Fig. 1-2-9-7

See I-2-13, Step (9)-(10) to calculate the "F-dist".

Fig.1-2-9-7 describes "P-distance" and "F-distance".

$$\text{"P-distance"} = \text{"F-dist."} - (2 \times \text{"B"})$$

where,

"B" is width from edge of the Transducer to edge of Mounting holder. (Refer to Fig.1-2-9-8)

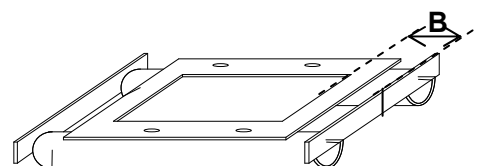

Fig. 1-2-9-8

1-a-7. Surface treatment

Prepare the pipe at the intended flow measurement point, making sure it is clean and free of loose material. Sand as necessary to remove any high spots. However, be sure to maintain the original curvature of the pipe and avoid eradicating the marks on the pipe.

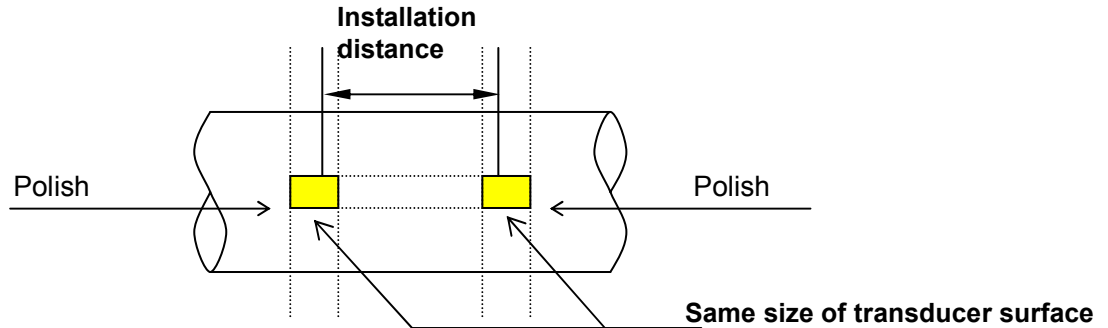

Fig. 1-2-9-9

1-a-8. Attachment of mounting fixture

- 1- Tighten the clips of the loop on the end of the wire with the red tip.
- 2- Loosen the clips of the loop on the other end of the wire ('A' in Fig. 1-2-9-10)
- 3- Adjust wire lengths so it fits the pipe circumference. You may use gauge paper or tape measure for reference.
- 4- Tighten the clips on the 'A' side of the wires.
- 5- Wrap the wires around the pipe. Clip end must be outside of the pipe, otherwise you may give damage on pipe surface.
- 6- Loop the ends of the wires on the turnbuckle fixture (Fig. 1-2-9-11).

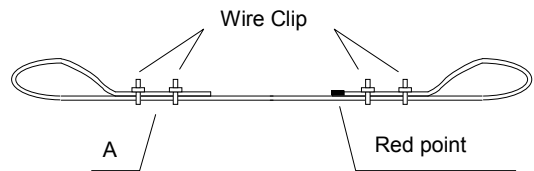

Fig. 1-2-9-10

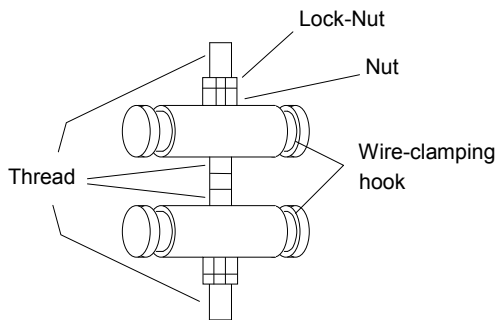

Fig. 1-2-9-11

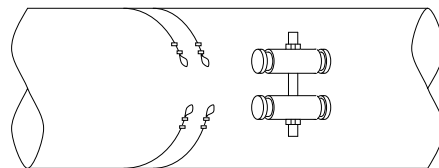

Fig. 1-2-9-12

**Note:** In case of Larger than DN1600mm, 2 turnbuckle fixtures may be used for 1 line for easy installation.

**Note:** To keep parallel of each wire, you can use gauge paper as reference.

7- Roughly position the probe holders under the wires at the target locations.

8- Adjust the transducer holders so they are positioned precisely. The red scored marking on the holders must be aligned with the line marked on the pipe.

9- Confirm that the positions are correct as calculated and adjust the turnbuckle fixture to tension the wires on the pipe.

[Note]

Holder position may shift during tensioning of the turnbuckle fixture. Check to insure that the proper position is maintained.

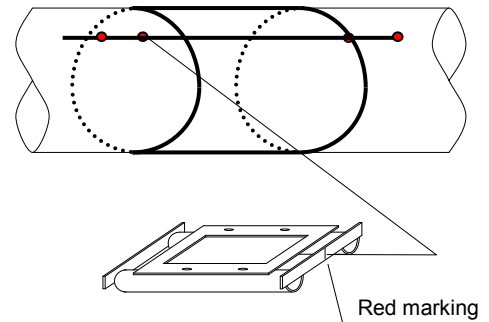

**Fig. 1-2-9-13**

10- Tighten the fixture until the holders are firmly fixed on the pipe.

#### 1-a-9. Transducer adhesives

1- Clean the contact surface of the probe.

2- Mix the two-part epoxy adhesive thoroughly.  
(Standard type adhesive can be ordered as part of installation components)

3- Generously apply the adhesive on the acoustic surface of the transducer to a thickness of about 3 - 5mm (Fig. 1-2-9-14).

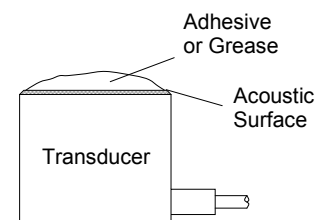

**Fig. 1-2-9-14**

**Note: It is recommended that grease be used temporarily as couplant when first installing the probes.**

**Check the gain setting or measuring status after installation to insure that there are no problems with installation. If there are no problems, fix the probes permanently with adhesive.**

**In that case, please remove grease on both of transducer surface and pipe before using adhesive.**

1-a-10. Probe setting

After installing the probes, confirm the distance between probes (F dist) again.

**Note: Transducer cables should face inward toward each other.**

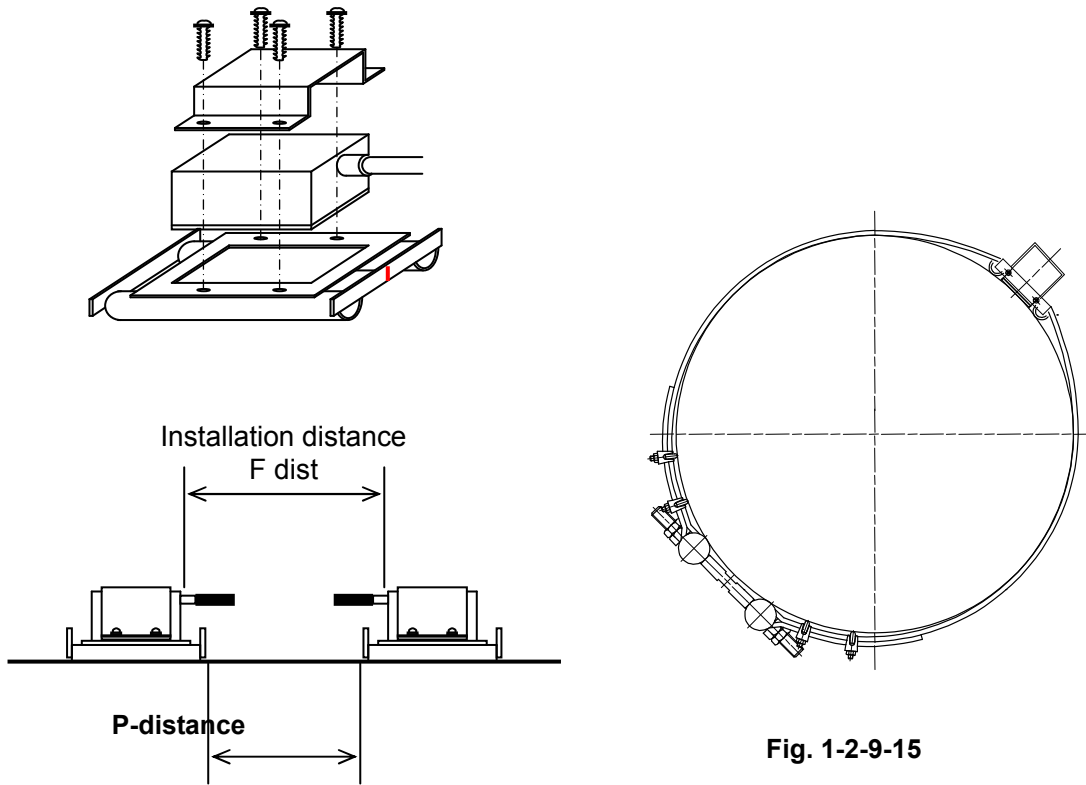

Fig. 1-2-9-15

**Note: To avoid keep parallel of each wire, you can use gauge paper as reference.**



**1-B. Direct Transmission Method (Z-method)**

- 1-b-1. Follow the procedure described under the reflection method, Section (1)-A, and paragraphs 1-a-1 to 1-a-4.
- 1-b-2. Using a pencil or marking pen, mark the pipe at both edges of the paper at the overlap and at the crease by using a pencil or marking pen to extend the lines outward from the paper onto the pipe.

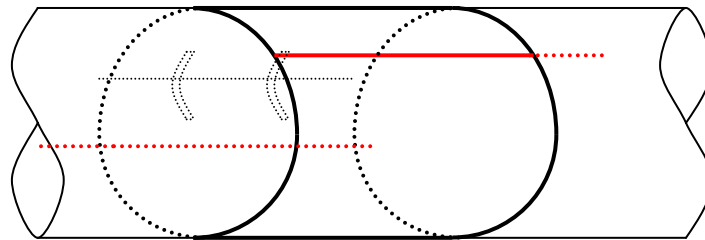

**Fig.1-2-9-16**

- 1-b-3. Position the Transducer-mounting holders on the pipe diametrically opposite each other, one on the side at the crease mark and the other on the side at the overlap and align in accordance with the lines marked on the pipe. Mark the 'P-distance' (distance from the outside edge of the holder). The calculated distance between the two probes is the fitting distance ('F-dist') which is the distance between the opposing inside edges of the probes.

**Note: Transducers should be positioned diametrically opposite the other.**

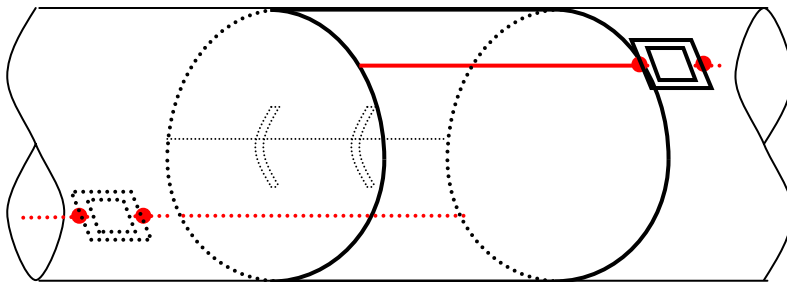

**Fig. 1-2-9-17**

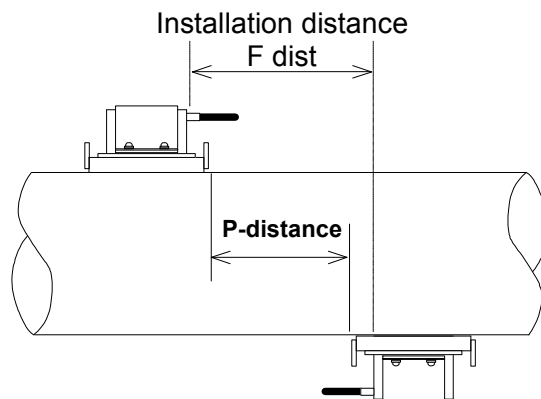

**Fig. 1-2-9-18**

### 1-C. Multi-Path Transducer Installation

When more than 2 pairs of transducers are employed, the basic procedures for mounting transducers for single paths are also used in multi-path installations.

2 channel: Gauge paper should be double folded to divide the circumference by 4.  
Follow the same steps used to install single path transducers.

**Note: One additional pulser module is required.**

4 channel: Triple fold the gauge paper to divide the circumference by 8.  
Follow the same steps used to install single path transducers.

**Note: Three additional pulser modules and a multi-path junction box are required.**

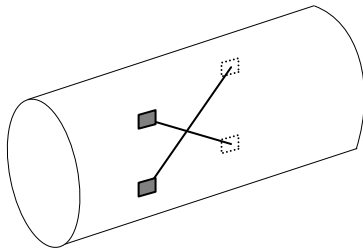

Fig. 1-2-9-19

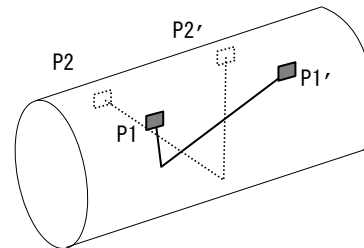

Fig. 1-2-9-20

## (2) Transducer Installation for Small Diameter Pipes (less than 250mm)

The V-method (reflection method) is generally recommended for small pipe diameter applications although the Z-method (transmission method) may also be used when conditions are poor, such as for rusty pipes, which reduce echo signals.

### 2-A. Reflection Method (V-method)

2-a-1. Wrap gauge paper around the pipe where you intend to make the flow measurement as shown in Fig. 1-2-9-21. Make sure the paper is long enough to overlap and that the overlapping edge is square. Gauge paper may be ordered and included in the standard installation kit.

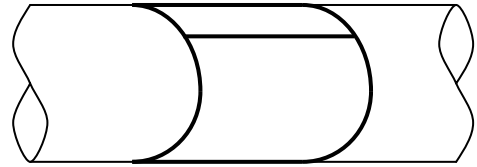

Fig. 1-2-9-21

2-a-2. Using a pencil or marking pen, extend the line created by the overlap outward from each edge of the paper onto the pipe. (Fig. 1-2-9-22). Remove the gauge paper.

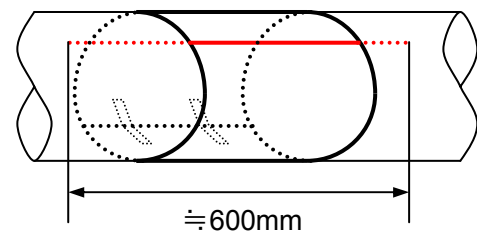

Fig. 1-2-9-22

2-a-3. Prepare the pipe at the intended flow measurement point, making sure it is clean and free of loose material. See I-2-13 (Step 9-10) to determine the separation distance, "F-dist", between the transducers and draw a line to mark these points. Sand the pipe surface where the transducers are to be positioned. The size of the sanding area should be 20mm inward from the line and 30mm outward from the line and 35mm in the radial direction as shown in Fig. 1-2-9-23.

**Note: A wider sanded area can be prepared which would enable easier transducer installation but make re-painting of the pipe surface more difficult.**

**Note: See I-2-13 Step (9)-(10) to calculate F-dist.**

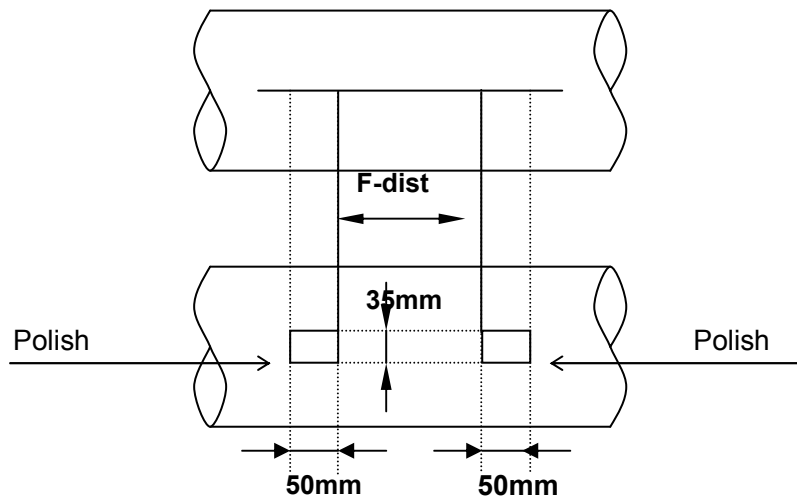
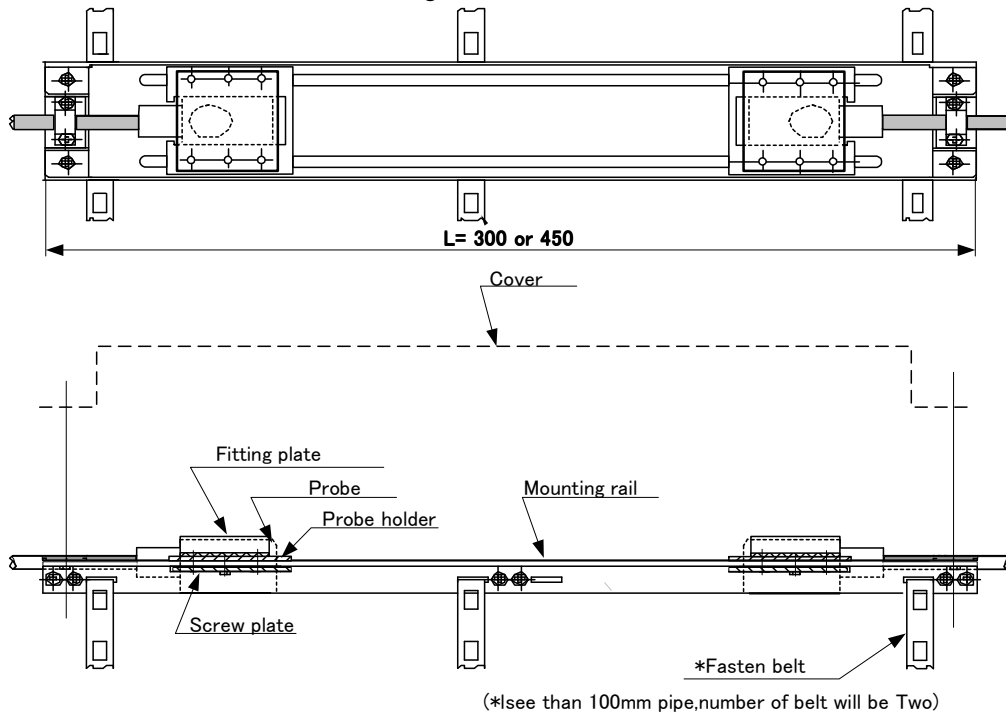

Fig. 1-2-9-23

2-a-4. Remove transducer cover from mounting fixture kit.

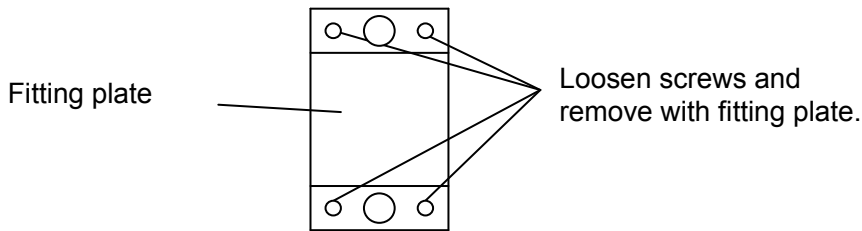

**Fig.1-2-9-24** Mounting fixture kit assembly

The mounting fixture kit is available in two lengths, standard length of 450mm and optional length of 300mm. The 300mm-length fixture is used for small pipes of diameters less than 100mm.

2-a-5. Removal of fitting plates

The fitting plates are attached to the mounting fixture kit with 4 screws. Use a Phillips screwdriver and unscrew and remove these screws and lift off the fitting plates (2).



**Fig.1-2-9-25** Fitting plate

2-a-6. Transducer holder

Loosen screws of the transducer holder (one side OK) to allow movement.

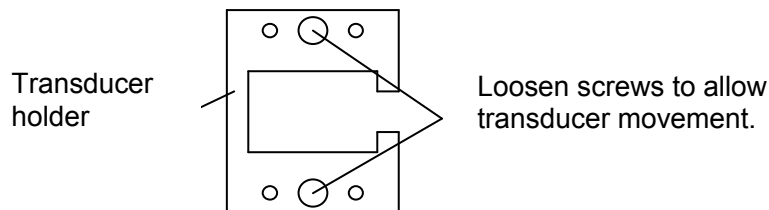

**Fig.1-2-9-26** Transducer holder

2-a-7 Installation of Mounting Rail on Pipe

Install the mounting rail with the fastening belts.

The transducers should be positioned on the sanded area of the pipe as shown in Fig. 1-2-9-27.

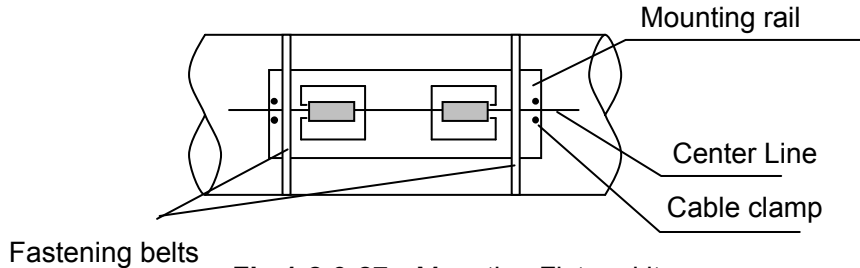

Fig.1-2-9-27 Mounting Fixture kit

The fastening belts consist of 3 parts as shown below.

The parts are easy to assemble for binding of the mounting rail.

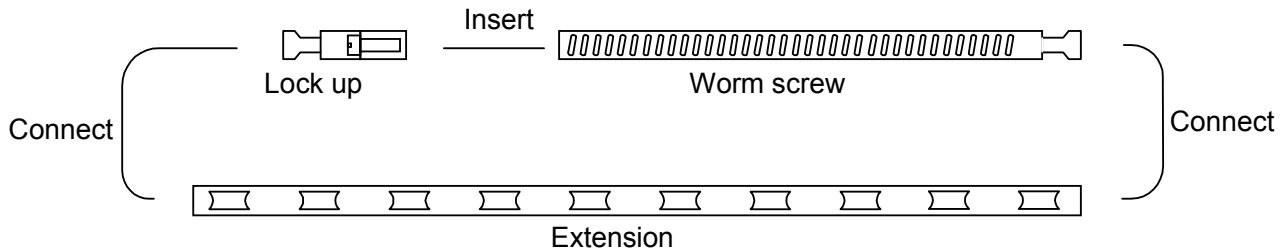

Fig.1-2-9-27 Fastening belt parts and assembly

2-a-8. Applying adhesive to the transducers.

- 1- Clean up contact surface of the transducers.
- 2- Mix the two part epoxy adhesive thoroughly.  
(Standard adhesive can be ordered as part of installation components.)
- 3- Generously apply the adhesive on the acoustic surface of the transducer to a thickness of about 3 - 5mm (Fig. 1-2-9-29).

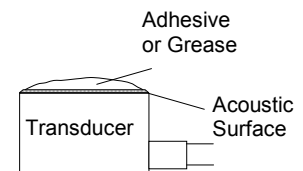

Fig. 1-2-9-29

**Note: It is recommended that grease be used temporarily as couplant when first installing the probes.**

**Check the gain setting or measuring status after installation to insure that there are no problems with installation. If there are no problems, fix the probes permanently with adhesive.**

**In that case, please remove grease on both of transducer surface and pipe before using adhesive.**

### 2-a-9 Transducer Setting

Fasten the belts and check to insure that the mounting rail position is parallel to the pipe axis and then firmly tightening the belts.

After the mounting rail is fixed in such manner, set the transducers into the holders in the fixture. The probes should be positioned on the sanded area of the pipe and the distance between the center marks of the two transducers should be the determined F-dist.

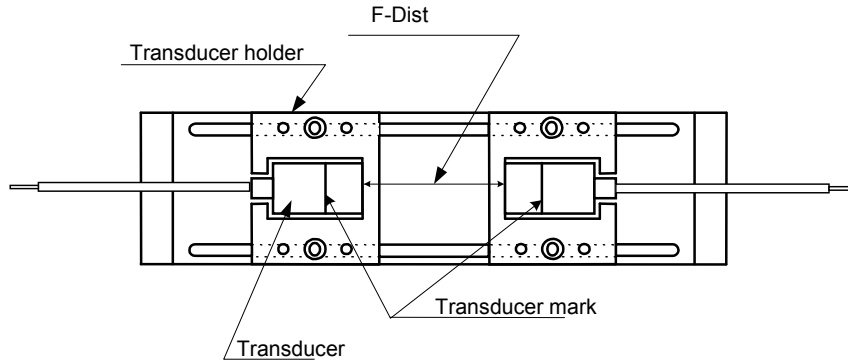

**Fig.1-2-9-30** View of Transducer Setting Prior to Mounting Plate Installation

**Note: Transducer cables should be outward each other.**

Confirm correctness of all conditions and tightly fasten the screws on the fixture plates and secure the transducers. Replace the fixture cover with screws.

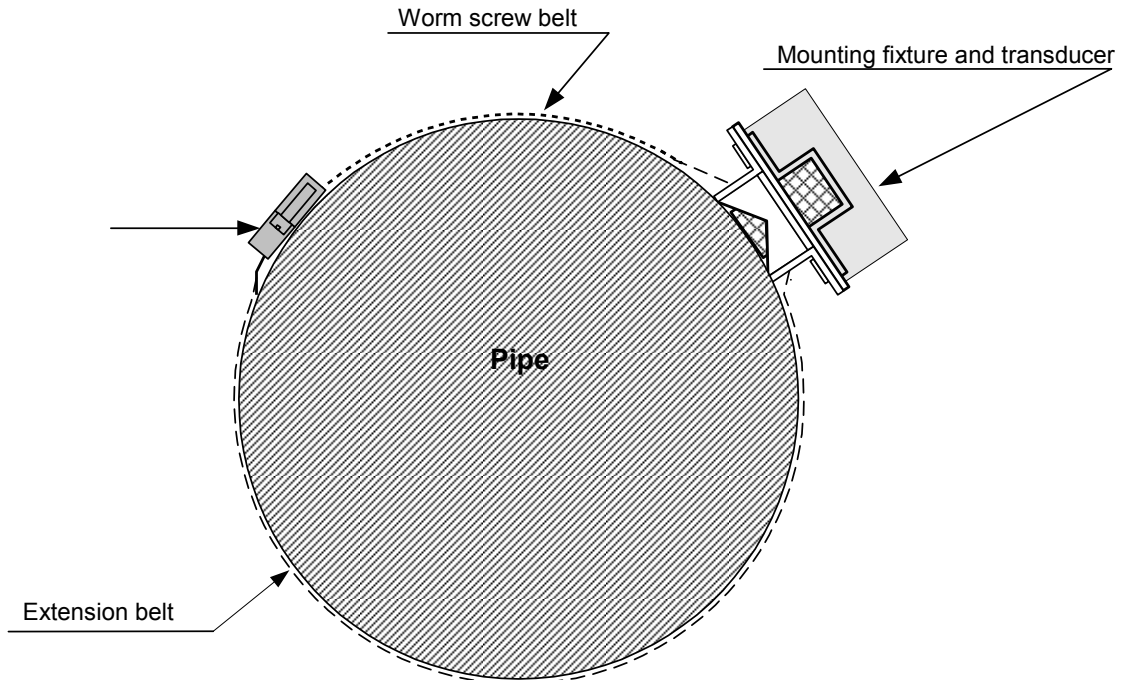

**Fig.1-2-9-31** View of Completed Installation of Transducers for Small Dia. Pipe

[ Reference ]

For Z-method installation refer to "1-B. Direct Transmission Method (Z-method)".

For Multi-channel installation refer to "1-C. Multi-Path Transducer Installation".

## I-2-10. Transducer Cable Treatment for Main Unit

Cable treatment will be divided 3 part.

Step1; Outer sheath part

Step2; Inner sheath part

Step3; Core part

Cable is composed as below.

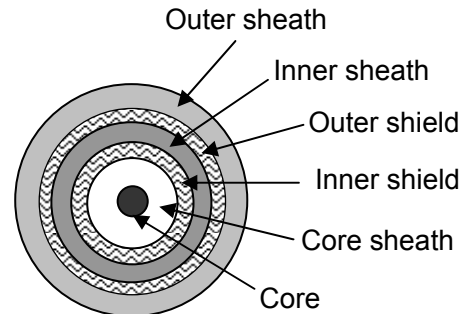

Cable section

### Step 1; Outer sheath treatment

1. Measure 40mm from the cable edge.

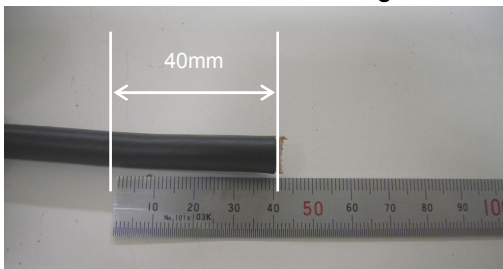

2. Make slit around cable circumference at the point.

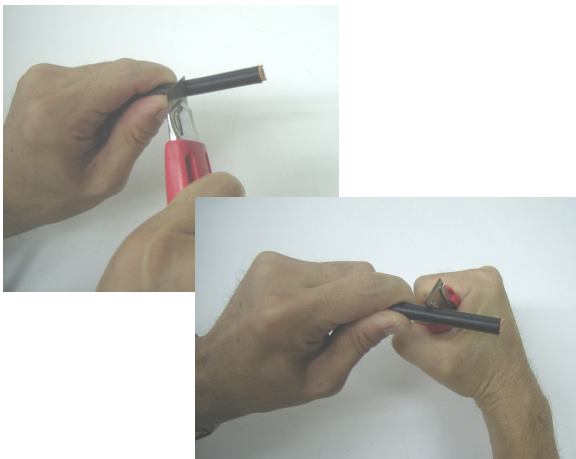

NOTE: Do not damage shield part by over slitting.  
Please remain sheath thickness as around 0.1mm at least.

3. Make slit to outside direction as below.

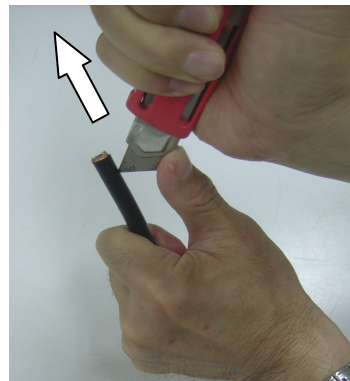

4. Remove outer sheath.



5. Fold back outer shield.



## Step 2; Inner sheath treatment

1. Make slit at the point where folding back outer shield.

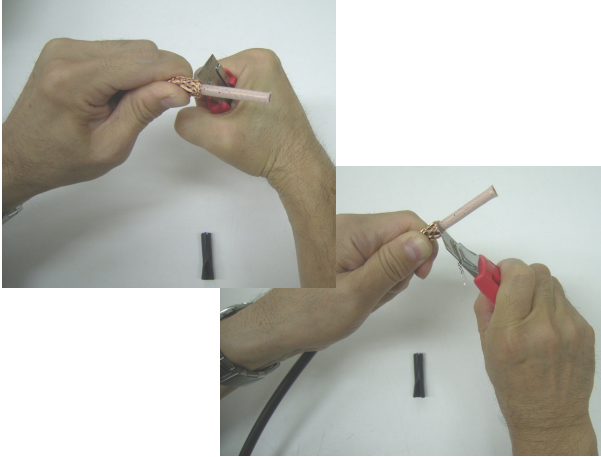

NOTE: Do not damage shield part by over slitting.  
Please remain sheath thickness as around 0.1mm at least.

2. Twisting inner sheath a bit to let it loose.



3. Make slit to outside direction as below.

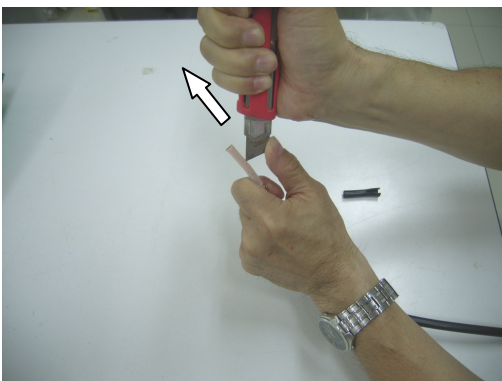

4. Remove inner sheath.



5. Fold back inner shield as below.

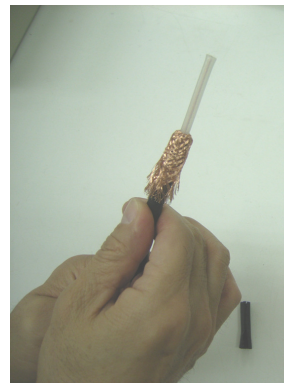

6. Wrap both shields inner and outer together by insulating tape with 15mm left.

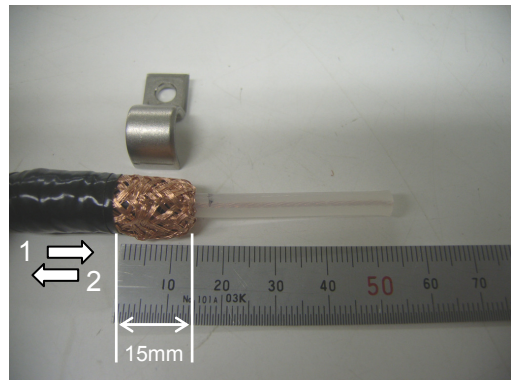

Note; Start from position 1 (left side) to position 2 (right side).  
Then back to position 1 again as go and return.



### Step 3; Core part treatment

1. Measure 3mm from shield return point.

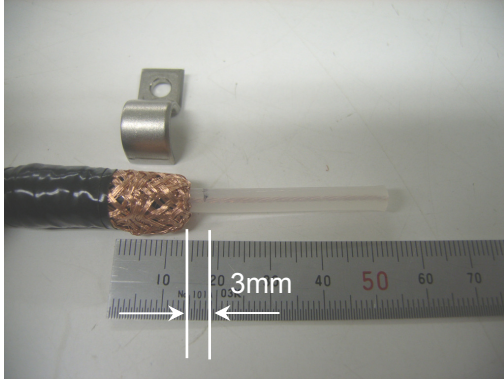

2. Make slit at the point where 3mm from folding back shields checked on above.

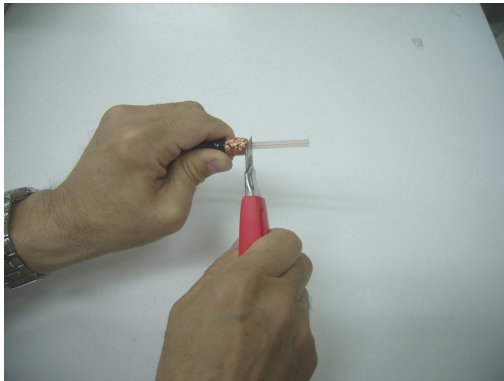

NOTE: Do not damage core part by over slitting.  
Please remain sheath thickness as around 0.1mm at least.

3. Twisting core sheath for let slit larger.



4. Wring off the core sheath slowly.

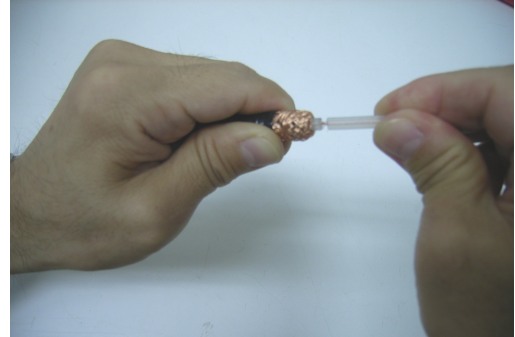

5. Confirm 3mm core cable as left as below.

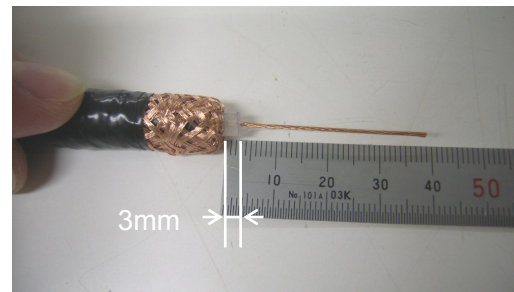

6. Cut core cable left as 10mm.

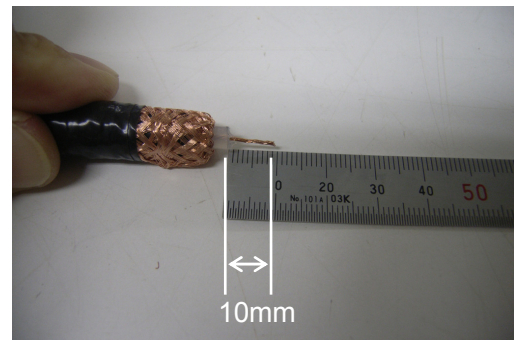

7. Completed.



Note; When you would like to soldering treatment as additional, we recommend to do it only at the tip. Otherwise core might break at the base.

## I-2-11. Cable Connection Treatment With Chemical Binder

Chemical binder can be supplied if required

- (1) Before starting cable treatment, both end of cable sheath should be filed off elaborately by included sandpaper to stick chemical binder onto cable very well.

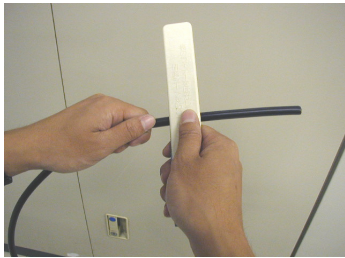

- (2) Strip coaxial cable as in photo below. (Approx. 70mm)

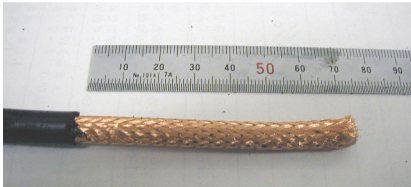

- (3) Bundle outer shield for soldering. (6 bundles are recommended.)

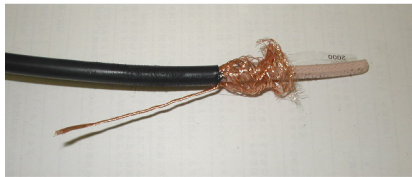

- (4) Remove sheath around inner shield. (Approx. 55mm)

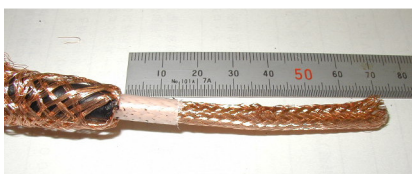

- (5) Bundle inner shield for soldering. (6 bundles are recommended.)

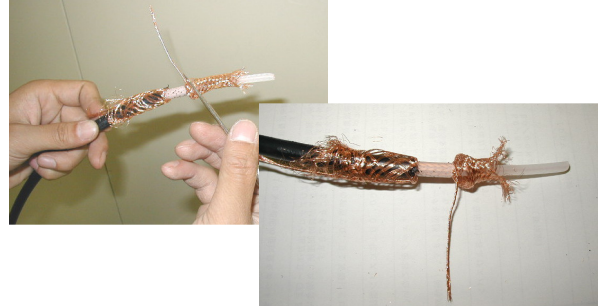

- (6) Remove Inner sheath around core cable. (Approx. 40mm)

Note:  
Pliers may be used to loosen the sheath from the core, which makes it easier to remove the sheath.

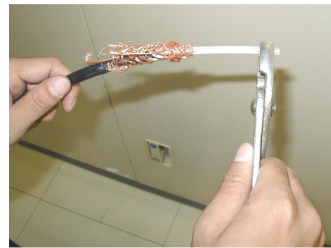

- (7) Follow the same procedure for the other cables.

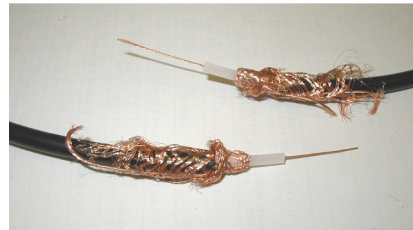

- (8) Join and solder the cable cores. Joining only the tips of the cores is recommended.

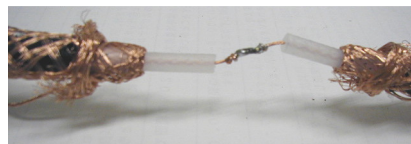

Joint must be double twisted as above.

- (9) For certain connections, it may be suggested to cover the cable cores using the removed

sheath as shown. (Suggestion only)

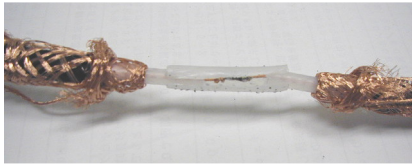

You can skip this step.

- (10) Wrap electrical tape or contained self-adhesion tape around the core lines.



- (11) Join and solder the braids of the inner shield together.

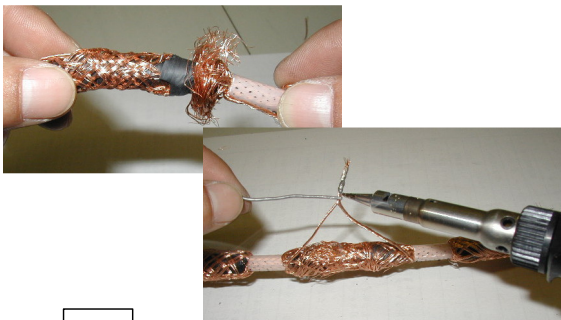

Joint must be double twisted as above.

- (12) Wrap electrical tape around the inner shield.

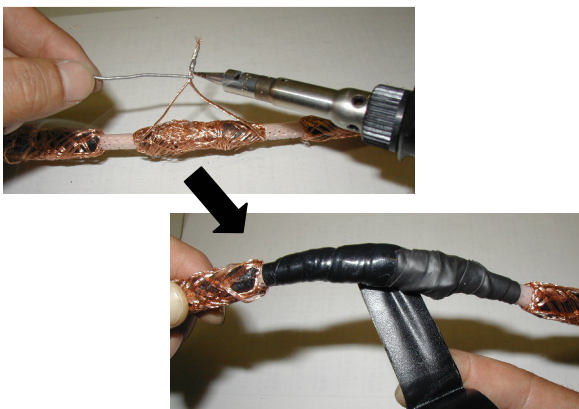

Note; If return shield length is too short, please use included metal net as extra-shield.

- (13) Join and solder the braids of the ends of the outer shield together and wrap with

electrical tape similar to steps (11) and (12).



- (14) Place the joined cable in the center of the mold casing cavity.



- (15) Seal the ends of the mold casing with tape.



- (16) Attach funnels as shown in the photo below.



- (17) Mix and prepare the resin liquid then pour it into the mold casing.  
Allow resin to harden.  
This completes the cable joint.

## I-2-12. Installation Outfit

Standard component of outfit is as follows,

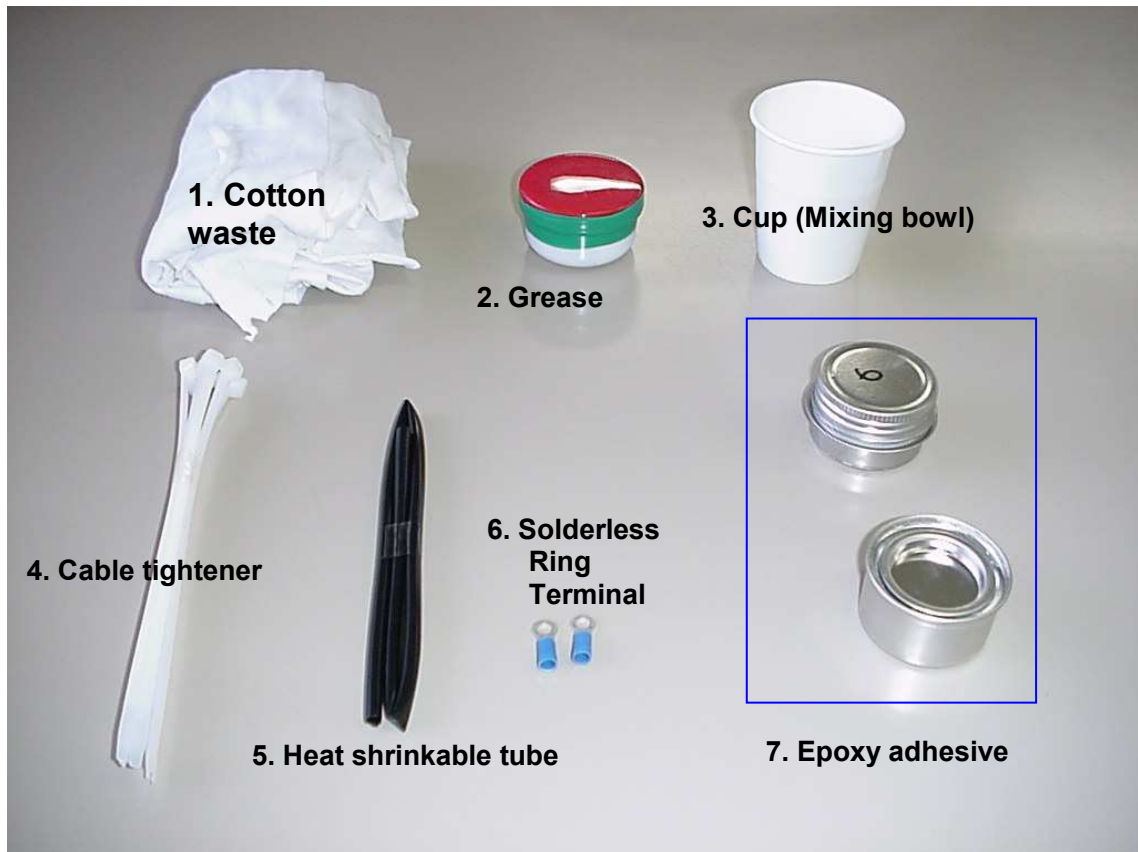

No.	Item Name	Description
1.	Cotton waste	for cleaner
2.	Grease	for temporary installation
3.	Cup (Mixing bowl)	for mixing two adhesive (item 7)
4.	Cable tightener	
5.	Heat shrinkable tube	for ground line of probe coaxial cable
6.	Solderless Ring Terminal	for ground line
7.	Epoxy adhesive	for probe installation permanently
	Note; Please mix two (2) liquids with the same volume from each can.	

## I-2-13. Input parameters by Commissioning software

Commissioning software is used to configure for the flowmeter by a personal computer.

### (1) System requirements

- OS : Windows 98 or later
- Display: 640 x 480 or higher
- Port : Serial Port EIA-232C (RS-232C) required  
(NOTE: USB-serial converter available.)

### (2) Software installation

Copy "FlowConfig" folder to any directory of your computer. This folder includes two softwares for commissioning & application. Notice that these programs should be used by combination.

### (3) Connection to main unit

#### CAUTION

1. Connection cable length must be less than 3 m long to comply with EC directive.
2. Do not connect the connection cable to LAN connector of the personal computer, that may damage the flowmeter main unit and/or the personal computer.

- a. Connect RJ-45 straight cable to **Digital Port 2** of the main unit.
- b. Connect cable to PC by using RJ-45 / RS-232C converter.
- c. Turn main unit power ON.

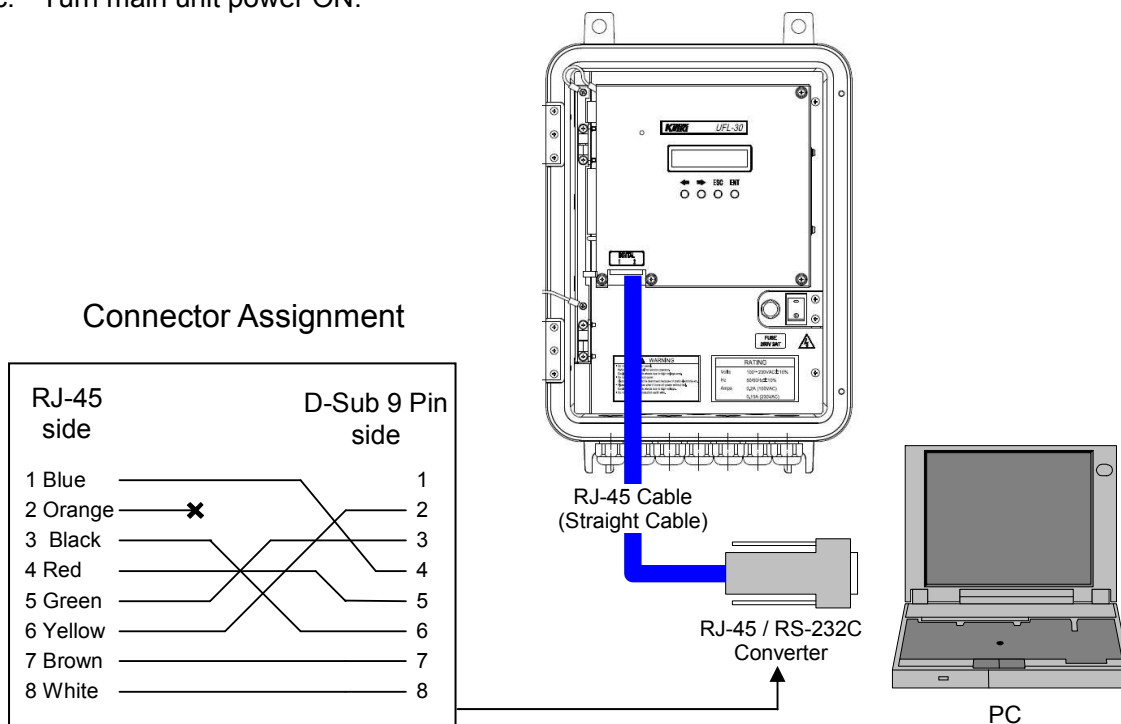

### (4) Startup software

After connecting the PC to the flowmeter main electronics unit, double click the commissioning software, "FlowConfig\_V\*\*\*.exe", to be boot up. (V\*\*\* shows the software version.)

Note: "Localize.exe" does not work independently.

**"In the beginning"**

**Meaning of column color**

Please be noted that each color of columns on software are as follows,

Column Color	Status
<b>Blue</b>	Before read-out from main unit.
<b>White</b>	After read-out from main unit.
<b>Green</b>	When value in the column changed.
<b>Yellow</b>	When writing is Error. Entered value may be the out of range.

**Meaning of button**

- "Read" refers to reading out of parameters from the flowmeter main unit.
- "Write" refers to completion of rewriting of parameters to the flowmeter main unit. Note that only rewriting of value of each column is not effective against the main unit.
- "Next" refers to proceeding to next menu..
- "Back" refers to returning to previous menu.
- "Cancel" refers to cancel of setting.
- "Close" refers to closing menu.
- "Start" refers to start of Auto Gain Adjustment.
- "Clear" refers to set zero to History Value.
- "OK" refers to agreement.

**(5) Communication speed setting**

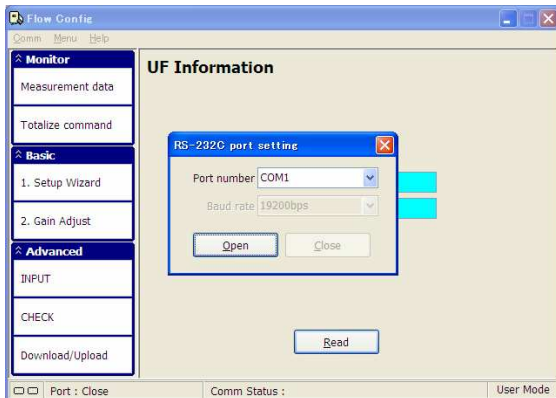

Select Com Port No. and communication speed.  
Default speed is 19200 bps.  
Press "OPEN".

Note: Please set communication speed on PC side as same as setting baud rate on this tab.

**(6) Serial number check**  
"UF Information" opens automatically.  
Click "READ" button.

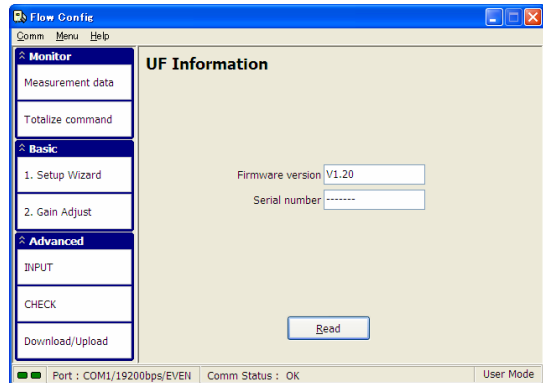

If communication between the PC and flowmeter main unit is successful, the firmware version and serial number of the main electronics unit will appear.

**(7) Setup Wizard for basic configuration**

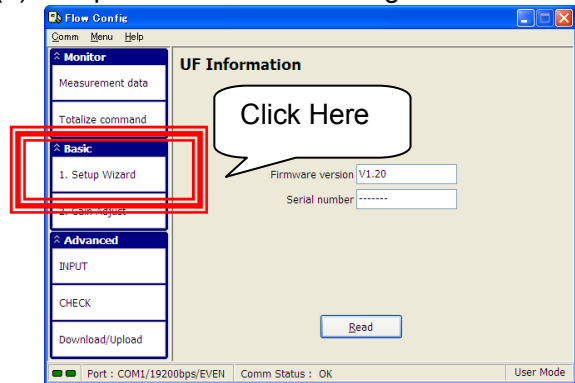

When click "BASIC-Setup Wizard", Wizard menu will open.

**(8) System Setting**

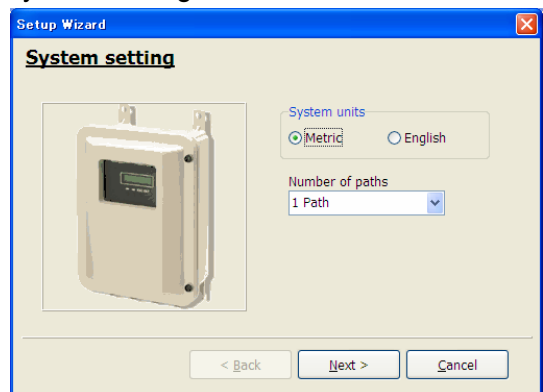

Select "System units" and "Number of path";  
"Metric " or "English"  
"1 Path" through to "4 Path"  
then, Press "Next".

Metric	English	Conversion reference
mm	in	1[mm] = 0.0393701[in] 1[in] = 25.4[mm]
M	ft	1[m] = 3.28084[ft] 1[ft] = 0.3048[m]
m/s	ft/s	1[m/s] = 3.28084[ft/s] 1[ft/s] = 0.3048[m/s]

English	Conversion reference
ft <sup>3</sup>	1[m <sup>3</sup> ] = 35.3147[ft <sup>3</sup> ] 1[ft <sup>3</sup> ] = 0.0283168[m <sup>3</sup> ]
gal (U.S. fluid gallon)	1[m <sup>3</sup> ] = 264.172[gal] 1[gal] = 3.785411784[L]
bbl (Standard barrel for liquids)	1[m <sup>3</sup> ] = 8.38641[bbl] 1[bbl] = 119.240471196[L]
acf	1[m <sup>3</sup> ] = 8.107132e-4[acf] 1[acf] = 1233.48184[m <sup>3</sup> ]

(9) Pipe, Sensor and Fluid type  
Input and Select all data.

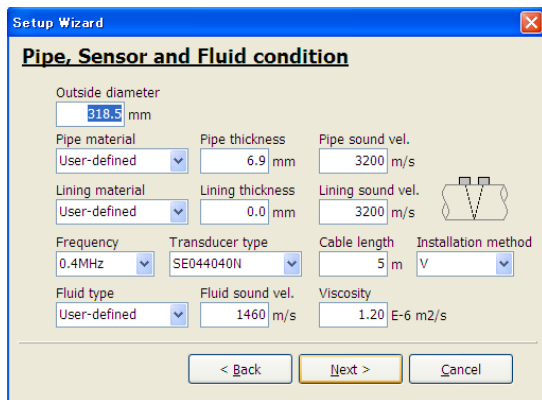

For "Pipe", "Lining" and "Fluid", their sound velocity values are automatically defined when you select the listed material or fluid. They are nominal values.

If you'd like to select other material or fluid not listed, select "User-defined" and enter new sound velocity value depending on your fluid temperature at each column.

Measuring coefficient parameter will be calculated by using these site data on the next step as "**Localization**" function. When "User-defined" is selected, Localization can not be applied.

After select and entering values, press "Next".

(10) Localization setting

Selection window for Localization function. Usually, Localization should be applied and "4" is selected for Trigger Number.

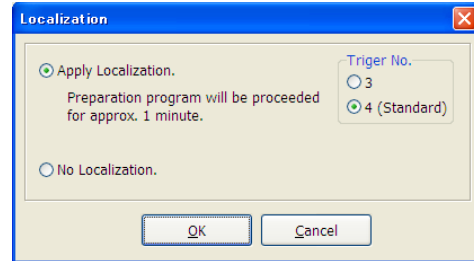

Press "OK" and calculation for Localization starts at once.

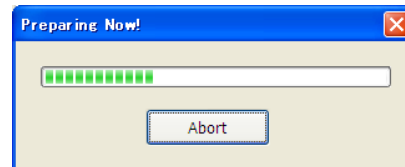

When "Cancel" or "Abort", go back to (9).

When "User-defined" was selected at (9), the following window will be appeared. Then confirm and press "OK".

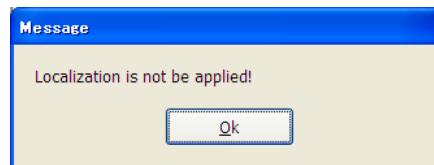

(11) Confirm mount distance

Calculated distance between transducers will be shown as below.

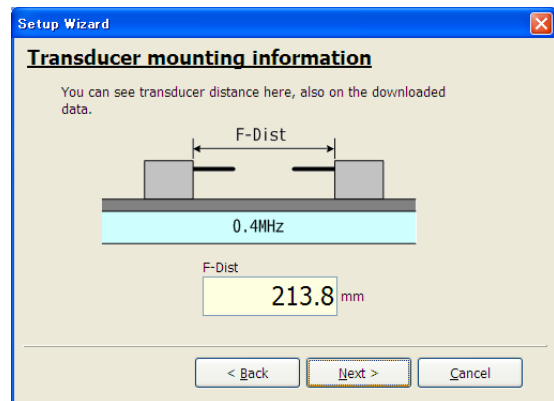

These values should be memorized for proper sensor installation (see Chapter 1-2-9), "Transducer Installation Procedure".

(12) Unit Setting

Exponents and flow rate unit will be selected on this part.

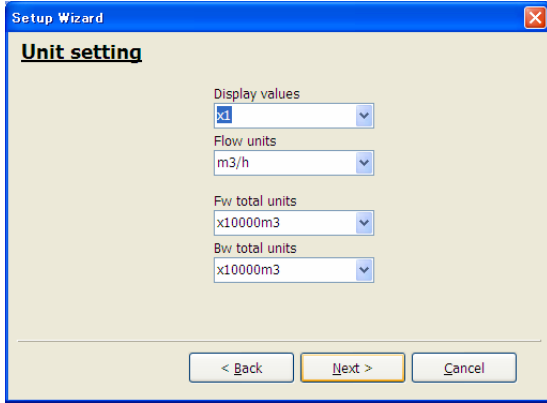

(13) Analog output range setting

Analog range and decimal position will be defined on this part, please select and input.

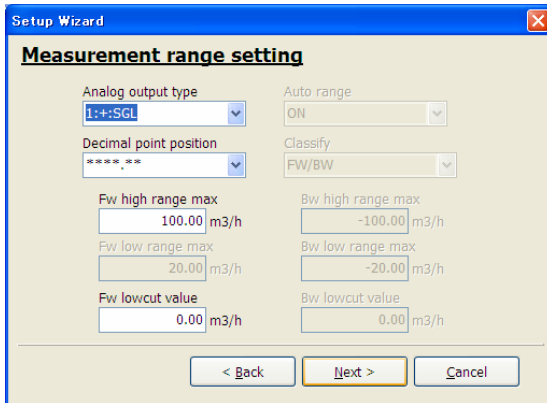

(14) Alarm setting

All alarm setting could be defined on this part. You may set at Advanced menu later.

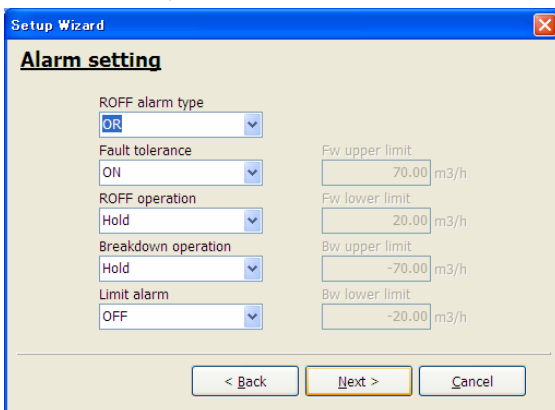

R-Off	No receiving echo warning
Fault Tole.	Halt setting for alarm
Breakdown	Hardware breakdown warning
Limit Alarm	Alarm activates exceeding limited range

(15) Contact Output setting

You can select contact parameter, invers or pulse width on this part.

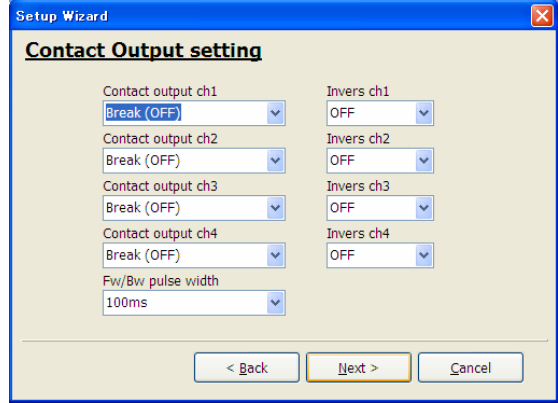

(16) Digital output setting

You can select protocol of digital output.

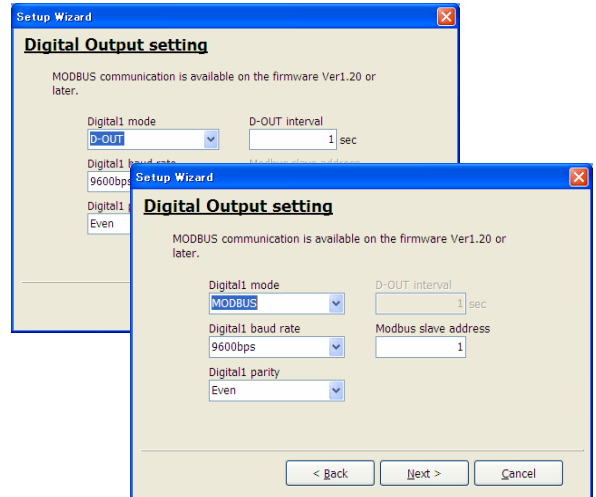

Default is D-OUT (original protocol). When MODBUS selected, please set slave address.

(17) Online-Upload

As a final step, you can upload all set parameter into on-lined-main unit.



Then please click "Finish" to exit wizard then skip to (18).



## Offline installation

If you would like to upload later on, you can also save all set parameter into your PC.

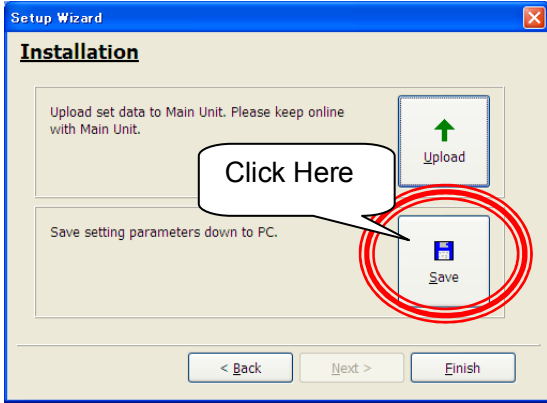

To upload file saved into your PC to flowmeter, select "Download/Upload" tab as below.

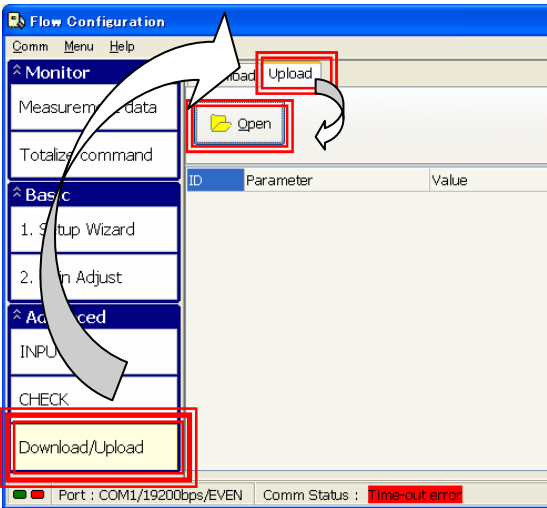

Select "Upload" tab and open the parameter file. Then click Upload button as below indicated.

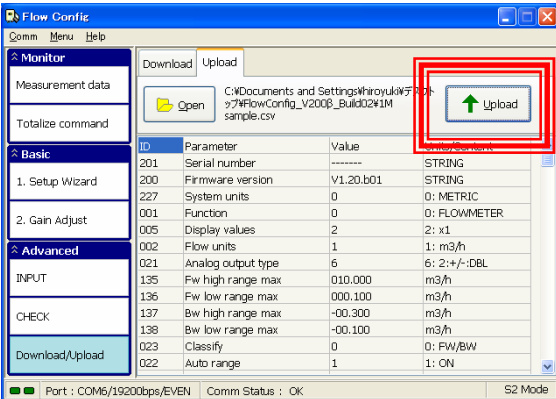

Then please go to (18).

## Flow Measurement

Transducer installation should be completed.  
Pipe should be full-filled with fluid.  
Flow should be stable enough.

(18) Automatic Gain Adjustment  
Open "Basic" - "Gain Adjust".

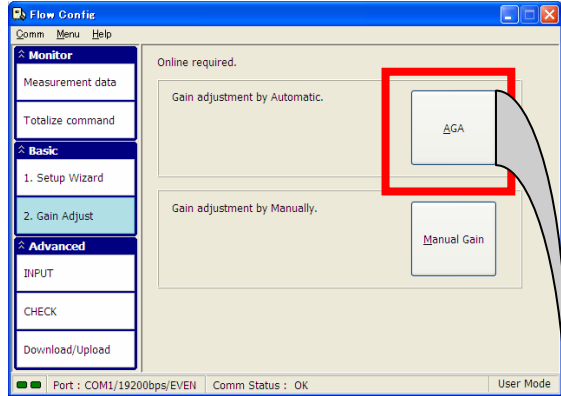

Click "AGA" button.  
Then "AGA window" pops up on the display.

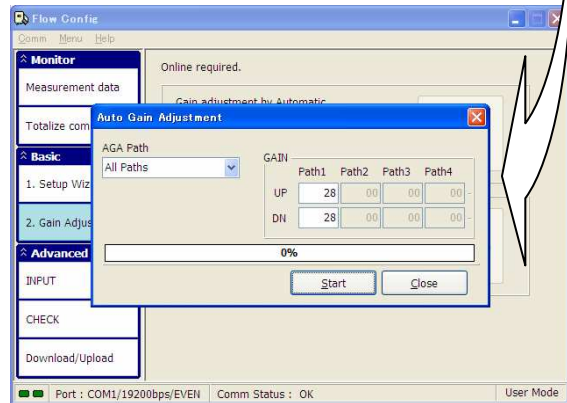

You can adjust the amplifier of the gain in order to obtain optimum echo reception. You may select "ALL paths" at once or select each path individually.

When you can not complete AGA settings in success, please refer to below and try again. Otherwise please contact our representatives.

Manual Gain function is used by a person who can monitor the receiving waveform of the Amp-out terminal on the main PCB with an oscilloscope.

Meaning of Error Messages are the follows.

**[Error Messages]**

**aa) “bW” : Bubble Warning**

The error will be indicated when pulse height fluctuates during AGA setting due to fluid conditions like air bubble contained. In such case, you might be required flow condition change or change path method to shorter path. (ex. V method to Z method.) Then try again AGA function.

**bb) “wW” : Wave distortion Warning**

The error will be indicated when required ratio of pulse height for AGA setting can not be kept due to pipe conditions like inner corrosion. In such case, you might be required mounting position change or change path method to shorter path. (ex. V method to Z method.) Then try again AGA function.

**cc) “ROFF” : No receiving echo Warning**

The error will be indicated when any echo can not be detected on transducers.

- Mounting distance
- Mounting direction
- Cable connection
- Fluid condition
- Pipe condition
- Parameter settings
- .... and so on.

In such case, please check each cause and improve. Then try again AGA function.

**(19) Final check**

Open "Monitor-Measurement data".

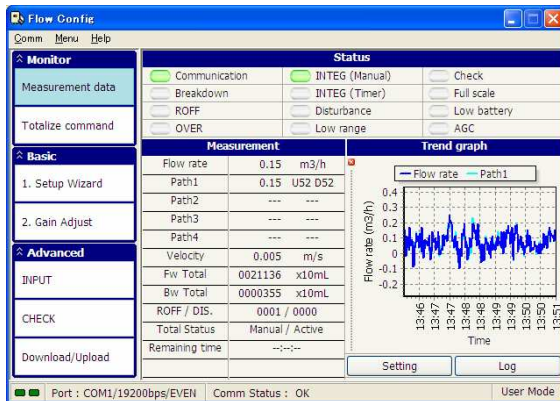

Commissioning is completed when the flowmeter starts to show flow rate measurements without any alarm indication.

Item	Instruction
Communication	Com. status between PC and Main unit
Breakdown	Breakdown alarm
ROFF	No receiving echo warning
Over	Limit alarm
INTEG (Manual)	Totalizing status (Manual or Timer mode)
INTEG (Timer)	
Disturbance	Disturbance detection function status
Low range	Low range detection
Check	Check mode indication
Full scale	Full scale error when PV exceeds
Low Battery	Low battery alarm
AGC	Auto Gain Control function status
Flow rate	Measured flowrate
Path X	Measured flowrate at each path
Velocity	Averaged velocity
Fw Total	Forward totalizing value
Bw Total	Backward totalizing value
ROFF / DIS.	Detection history (Q'ty)
Total Status	Totalizing function mode status
Remaining Time	Time indicates when timer mode

**Go to Chapter II "Operation "**  
**for setting output signals.**

# New Feature of extra function on "Flow Config"

## On-line Trend Graph

- This trend graph will indicate following items
- Average flowrate of all path
  - Average velocity of all path
  - Flowrate of each path

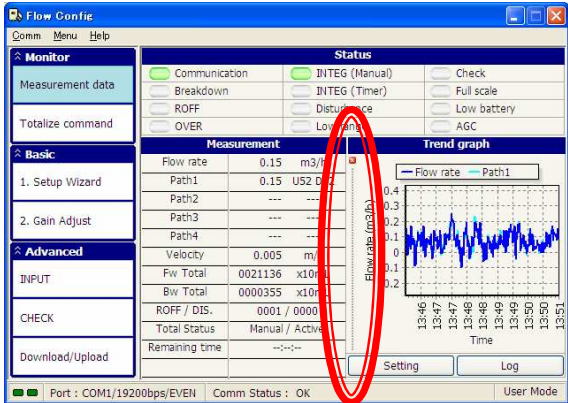

When you double click near circled line just on the line, graph part will pop up. Then you can extend larger as you intend to, as below.



The graph will back when you click close button. Graph will clear when double click on the graph.

## Logging function

You can see flow trend and also do logging all measuring data to your PC by using this commissioning software.

a) Set totalizing (if any)

You can set totalizing function by click "Totalize command."

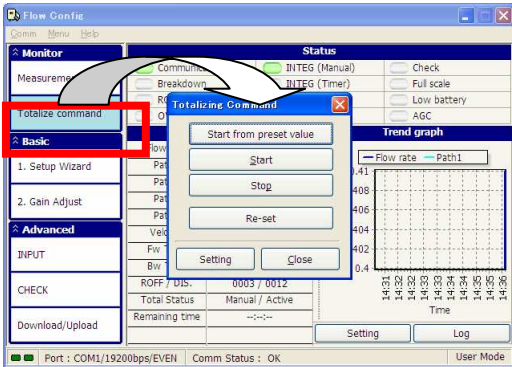

Start from...	Start from preset value
Start	Start Totalizing
Stop	Stop Totalizing
Reset	Reset Totalizing to 0
Setting	Move to the page "Advanced-Input-Totalizing setting"

b) Online-LOG

Click "LOG" button, you can set log data into your connected PC during online.

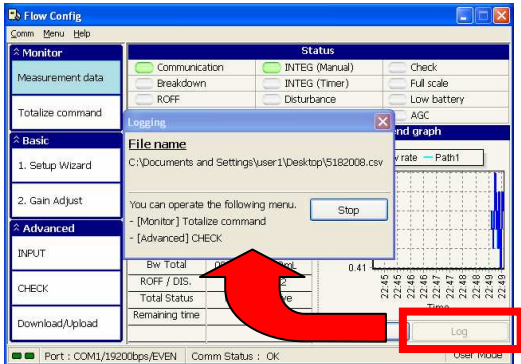

## **II. Operation**

## Chapter II INDEX

### II-1. Functions

#### Flow display

- Numerical section..... II-5
- Multipliers..... II-6
- Units of flow..... II-6
- Flow density..... II-6

#### Analog output

- System..... II-7
- Direction..... II-7
- Range..... II-7
- Output profile..... II-7
- Operation with no received signal..... II-11
- Failure operation..... II-11
- Output calibration..... II-11
- Loop check (analog output check).... II-11

#### Integration (Totalizing)

- Totalizing display..... II-12
- Totalizing units..... II-12
- Totalizing start & Stop modes..... II-12

#### Relay output

- Operation..... II-13
- Totalized pulse width..... II-14
- R-off alarm..... II-14
- Logic inversion..... II-14

#### Confirmation of operational status

- Battery..... II-15
- Measurement aberrations..... II-15
- Detection of disturbance..... II-15
- High & Low Limit alarm..... II-15
- Checking flow direction..... II-16
- Clearing of ROFF,DIS occurrences..... II-16
- Analog output check..... II-16
- Check of range fixation..... II-16
- Check of path fixation..... II-16
- Acoustic velocity of fluids and Reynolds' number.. II-16
- Self-diagnostics..... II-16

#### Calibration

- Correction of measurement values..... II-17
- Flow volume cutoff..... II-17
- Smoothing..... II-17
- AGC..... II-17

#### Other

- Fault tolerance..... II-18
- Digital output (RS232C output).... II-18
- Flowmeter, flow velocity mode..... II-18

## Chapter II INDEX (cont.)

### II-2. Operation

II-2-1 Main operating unit layout.....	II-19
II-2-2 Startup and shutdown procedure.....	II-20
II-2-3 LCD and operating keys.....	II-20
II-2-4 Display layout and description.....	II-21
II-2-4-1 Measurement display.....	II-21
II-2-4-2 Menu screen.....	II-22
II-2-5 Menu Overview in LCD.....	II-23
II-2-6 How to operate (function by function).....	II-24
- Open Top menu.....	II-24
- Open Input menu.....	II-24
- Open Check menu.....	II-24
<b>[1] LCD display relation</b>	
a. Change indicating options on the display.....	II-24
<b>[2] Flow measurement relation</b>	
a. Change measuring unit.....	II-25
b. Change fluid density.....	II-25
c. Set high / low alarm.....	II-26
d. Prevent frequent changeover.....	II-27
e. Adjust measured value.....	II-28
f. Dampen output fluctuation .....	II-29
<b>[3] Analog output relation (4-20mA Current output)</b>	
a. Change output pattern.....	II-29
b. Change digits of flow rate display and/or measuring range. ....	II-30
c. Determining flow direction or range.....	II-31
d. Switching of double range.....	II-31
e. Set R-OFF warning.....	II-32
f. Set fault tolerance.....	II-32
g. Change analog output during R-OFF.....	II-33
h. Change analog output during Break Down.....	II-33
<b>[4] Integration (Totalizing) Function</b>	
a. Change totalizing unit .....	II-34
b. Control integration start and/or stop.....	II-34
c. Preset starting value of integration.....	II-35
<b>[5] Contact (Relay) Output Function</b>	
a. Use/Change contact output.....	II-36
b. Change pulse width.....	II-36
c. Switch contact type (Arbeit to Break contact).....	II-37

**[6] Digital output Function (RS232C)**

- a. Change baud rate ..... II-38
- b. Download parameters ..... II-38
- c. Change parameters through PC..... II-38

**[7] Check Function**

- a. Clear warning counter..... II-38
- b. Check analog output..... II-39
- c. Calibrate analog output ..... II-40
- d. Check measurement in single range..... II-41
- e. Check single path measurement..... II-41
- f. AGA function..... II-42
- g. AGC function..... II-44
- h. Confirm sound velocity & Reynolds number..... II-45
- i. Flowmeter self-diagnostics ..... II-46



**II-2-7 Output Operating during aberrations in measurement ..... II-47**

- Transition Diagram..... II-47
- Error code list..... II-48

**II-2-8 Error Message..... II-49**

## II-1. Functions

This chapter summarizes the functions of the ultrasonic flowmeter. Please refer to Chapter II-2 'Operation' for setting methods.

 <b>WARNING</b>
<ol style="list-style-type: none"> <li>1. Do not make the inner panel open when the equipment is working. High voltage parts causing electrical shock are inside.</li> <li>2. Do not take off a protective earth cable connecting front cover and enclosure.</li> <li>3. Do not take off a protective earth cable connecting panel cover and enclosure.</li> </ol>
 <b>CAUTION</b>
Do not make the panel cover take off when the equipment is working.

### Flow Display

Flow values are composed of numerical units, exponents and units of measurement. Large flow values can be expressed by combining exponents (powers of 10).

Normally volumetric flow is the unit of measurement used, but measurement can be converted to mass flow if liquid density is measured.

Example of display: 123,400,000 m<sup>3</sup>/h is displayed reflecting condition, 123.4E+6 m<sup>3</sup>/h

#### [Numerical section]

The numerical portion of the display consists of a maximum 7 digit sequence, including alphanumeric and decimal point although forward flow display consists of numbers and decimal point only, no symbols. (However the maximum measurable flow value is 99999.0.)

Flow display digits and decimal point position is determined by the input rendering for the max. forward flow value as set via the analog output setting screen. For example, the same measurement range setting can be expressed as a 2-digit integer (2 significant digits) when you input '10', and can also as a 2-digit integer and 3-digit decimal (5 significant digits) when you input '10,000'.

Up to 4 decimal places are possible and an error message (INPUT ERROR) is displayed when there are 5 or more digits, even if it is within the input range.

When measuring both forward flow and reverse flows, even if the input is 10,000 for max. flow in the forward direction and -10 for max. flow in the reverse direction, a 5 significant digit number (-10,000) will be displayed for reverse flow. Viewing this in another way, if a max. flow of 500,000 in the forward direction is input, a minus symbol will represent reverse flow and only a (measurement) setting up to -99.999 is possible. (When measuring reverse flows up to -500, please input 500.00 for forward direction flow.)

Display Digits	1	2	3	4	5	6	7
Forward Flow	5	0	0	.	0	0	0
Reverse Flow	-	9	9	.	9	9	9
Forward Flow		5	0	0	.	0	0
Reverse Flow	-	5	0	0	.	0	0



### [Multipliers]

Select multipliers from the following.

$10^{-6}$ ,  $10^{-3}$ , 1,  $10^3$ ,  $10^6$ ,  $10^9$

For example,  $10^3$  is expressed as  $\times 1000$ .

Exponents are not displayed when '1' is selected.

Note1: Setting cannot be done during the flow velocity measurement mode.

Note 2: LCD display exponential indicators may be described in this manual as 'E-6' or 'E+3', for example, instead of ' $10^{-6}$ ' or ' $10^3$ ' for reasons of visual clarity.

### [Units of flow]

Units of flow measurement can be selected from the following.

$m^3/D$ ,  $m^3/h$ ,  $m^3/min$ ,  $m^3/s$ , L/h, L/min, L/s, t/D, t/h, t/min, t/s, kg/h, kg/min, kg/s  
 $ft^3/D$ ,  $ft^3/h$ ,  $ft^3/min$ ,  $ft^3/s$ , bbl/D, bbl/h, bbl/min, bbl/s, gal/D, gal/h, gal/min, gal/s  
acf/D, acf/h, acf/min, acf/s

For example, 'D' would be expressed as '24H' and ' $m^3/s$ ' would be expressed as ' $m^3/sec$ '.

Note: Setting cannot be done during the flow velocity measurement mode. (m/s fixed)

### [Flow density]

Setting is required when using mass flow units.

Setting range: 0.100 to 9.000

Fixed unit is  $g/cm^3$ .

### **Analog output (4-20mA current output)**

This function converts the flow measurement range setting (zero to max. setting value) into a 4~20mA current output. Two output channels and 8 output patterns are provided.

- Each channel is insulated which allows current output reception from two separate locations.
- Output patterns are configured from 3 components: system, direction, and range.

Analog output operation can be set in the case of measurement aberrations (i.e. no received signal, equipment failure). Please refer to Fig. 4-4, Transition Diagram During Measurement Aberrations under Chapter II-2-7 'Output Operation During Aberrations in Measurement' for the condition of the LCD display, relay output, and output relative to analog output operation.

#### **[System]**

When 1 system output is selected, the same output from channels 1 and 2 will be obtained. As each channel is insulated, signal reception can be obtained from two locations.

When 2 system output is selected, the receiving signal is a combination of channels 1 and 2 and by adding this to flow volume, you can determine flow direction and range. This function is handy when you cannot use a relay output.

#### **[Direction]**

Selecting direction 1 allows measurement in the forward flow direction only.

Selecting direction 2 allows measurement in both the forward and reverse flow directions.

#### **[Range]**

Select single range to set 1 measurement range for 1 flow direction.

Select double range to set 2 measurement ranges (low range and high range) for 1 flow direction.

When flow is bi-directional, setting 2 ranges enables highest resolution for low flow volume independent of the high flow volume setting.

Range switching can be done automatically in accordance with the measurement value.

Note: When single range is selected, it is treated as high range.

#### **[Output profiles]**

##### **1. 1: +:SNGL (1 system, 1 direction single range output)**

Measures forward direction flow only. Same current values are output from channels 1 and 2.

One range.

Graph of flow relative to output current is shown below.

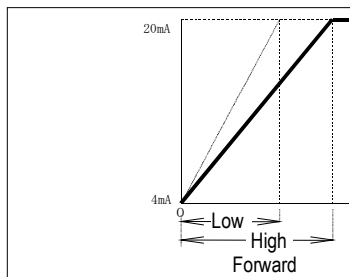

2. 1:+/-:SNGL (1 system, 2 direction single range output)

Measures forward and reverse direction flows. Measurement ranges for each direction can be independently set.

Graph of flow relative to output current is shown below.

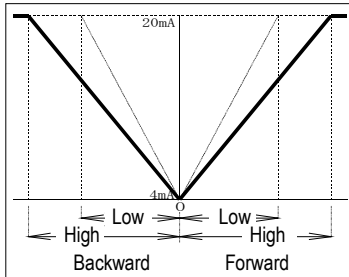

3. 1:+:DBL (1 system, 1 direction double range output)

Measures forward direction flow only. Same current values are output from channels 1 and 2.

Graphs of flow relative to output current are shown below.

Automatic double range

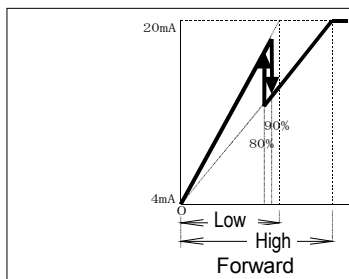

4. 1:+/-:DBL (1 system, 2 channel double range output)

Measures flows both in forward and reverse directions.

Measurement ranges for each direction can be independently set..

Graphs of flow relative to output current are shown below.

Automatic double range

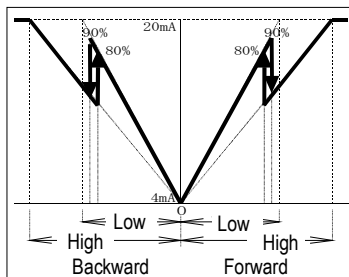

5. 2:+/-:SNGL (2 system, 2 direction single range output)

Forward direction and reverse direction flows are measured by channel 1 and channel 2 respectively. One range.

Graphs of flow relative to output current are shown below

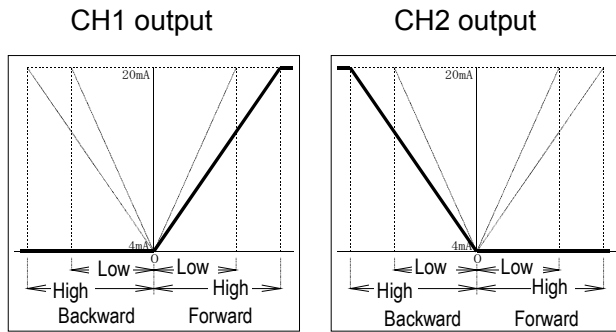

6. 2+:DBL (2 system, 1 direction double range output)

Measures forward direction flow only.

Channels 1 and 2 measure high range and low range respectively.

Graphs of flow relative to output current are shown below.

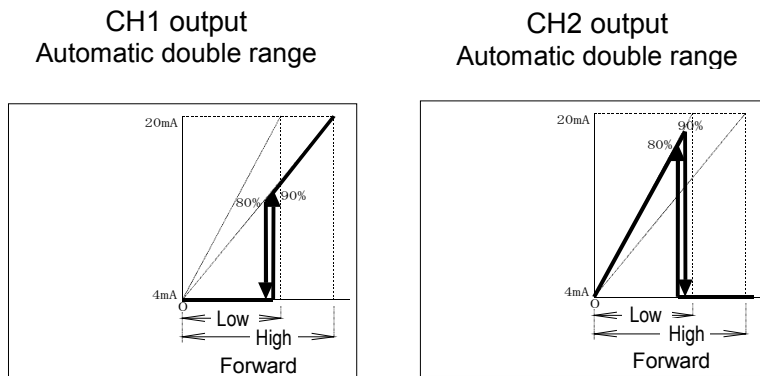

7. 2:±/DBL (2 system, 2 directional double range output)

Channels 1 and 2 measure forward direction and reverse direction flows respectively.  
 Channels 1 and 2 provide high range and low range measurements respectively.  
 Selectable channel switching based on flow direction or range.  
 Graphs of flow relative to output current are shown below.

**Direction change (FW/BW)**

CH1 output  
Automatic double range

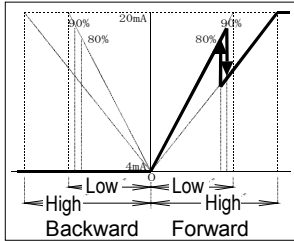

CH2 output  
Automatic double range

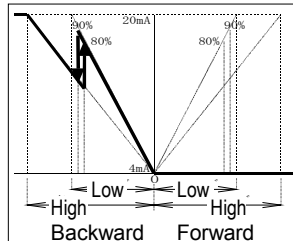

**Range change (HI/LO)**

CH1 output  
Automatic double range

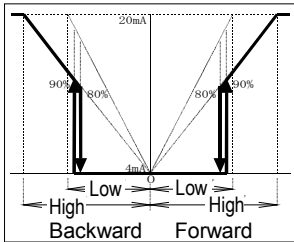

CH2 output  
Automatic double range

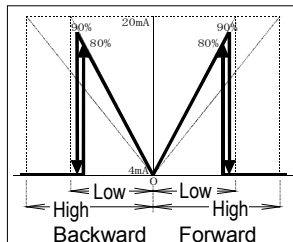

8. SPECIAL (Special Output)

Measures forward direction flow and reverse direction flow up to 20% of forward direction flow.  
 Current output range is 0.8mA for -20%, 4mA for 0, and 20mA for 100%.  
 Same current values are output from channels 1 and 2. One range.  
 Graphs of flow relative to output current are shown below

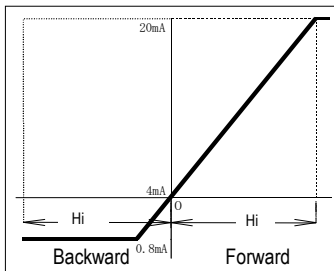

[Operation with no received signal (ROFF Alarm)]

In the event that there is no received signal and measurement cannot be made, the analog output status can be selected.

Operational setting can be selected from the following.

0%, HOLD, 100%, BURN OUT

[Equipment failure (B.D.) operation] (Note: B.D. =“Break Down”)

In the event of equipment failure (transmitter-receiver, counter, etc.) which prevents measurement, the analog output status can be selected.

Operational setting can be selected from the following.

0%, HOLD, 100%, BURN OUT

[Output calibration]

Output current is calibrated during product testing prior to shipment from factory and no recalibration at site is necessary. If recalibration becomes necessary for some reason however, the unit can be recalibrated according to the procedure described under Chapter II-2 ‘Operation’.

[Loop Test (analog output check)]

There can be Loop test on following current output.

5 points of 4mA, 8mA, 12mA, 16mA and 20mA.

## **Integration (Totalizing)**

Totalized value is composed of an alphanumeric sequence and unit of measurement. The alphanumeric display is expressed with a maximum of 7 digits. If the unit of flow is set as volumetric flow, the selectable totalizing unit to be set will be in volumetric flow units.

If the unit of flow is set in mass flow units, the selectable totalized flow unit to be set will be in mass flow units. However when setting mass flow units, it is necessary to know the density of the liquid being measured.

Totalized values are retained even when power is turned off.

### **[Totalized display]**

The alphanumeric sequence can be expressed up to 7 digits. Plus and minus independent display range is 0 to 9999999.

There are no decimal points in the totalized value display. For example, if the totalized value is  $100\text{m}^3$  and totalized unit is set at  $\times 1\text{m}^3$ , '0000100x1m<sup>3</sup>' is displayed. But if the totalized unit is set at  $\times 1000\text{m}^3$ , the display will be '0000000x1000m<sup>3</sup>'.

### **[Totalized units]**

Totalized units can be selected from the following.

- When flow is set in volumetric flow units,

NONE, x10000m<sup>3</sup>, x1000m<sup>3</sup>, x100m<sup>3</sup>, x10m<sup>3</sup>, x5m<sup>3</sup>, x1m<sup>3</sup>, x100L, x10L, x1L, x100mL, x10mL

- When flow is set in volumetric of USA flow units,

ft<sup>3</sup>, kft<sup>3</sup>, Mft<sup>3</sup>, bbl, kbbl, Mbbl, gal, kgal, Mgal, acf, kacf, Macf

- When flow is set in mass flow units,

NONE, x100kt, x10kt, x1kt, x100t, x10t, x1t, x100kg, x10kg, x1kg, x100g, x10g, x1g

### **[Totalizing start and stop modes]**

Totalizing can be selected for a fixed time either manually or with timer setting.

The [START] command initiates totalizing with a continuation of totalized values.

Totalizing can also be initiated from a preset value with the [PRESET START] command from the preset menu.

The [STOP] command ends totalizing.

Timer setting enables totalizing operation for a predetermined time only.

The timer can be set up to 99h59m59s (i.e. 99 hours, 59 minutes, 59 seconds). When the set time elapses, totalizing automatically ends.

During totalizing, an 'I' blinks at the upper right of the measurement screen and disappears when totalizing ends.

## **Relay (CONTACT) Output**

Totalized pulse signals and warnings can be output using the relay.

Signals can be allotted independently to each of the 4 contacts (relay channels, 1 to 4).

The output logic of relay channels 1 to 4 can also be independently inverted.

### [Operation]

Desired operational output for each relay channel can be selected from the list below.

BREAK	:	Relay always open.
MAKE	:	Relay always closed.
FW INTG (+ totalized pulse output)	:	Relay closes once for each rise in the totalized count on the forward flow side. Relay operation time can be changed by setting the width of the totalized pulse.
BW INTG (- totalized pulse output)	:	Relay closes once for each rise in the totalized count on the reverse flow side. Relay operation time can be changed by setting the width of the totalized pulse.
ROFF (no received signal)	:	Relay closed during warning for no received signal.
B.D. (break down)	:	Relay closed during break down failure warning.
B.D. or ROFF	:	Relay closed when warning is generated for either no received signal or failure.
HI-LMT (upper limit warning)	:	Relay closed when upper limit value is exceeded. For reverse flow determination is based on absolute value.
LO-LMT (lower limit warning)	:	Relay closed when lower limit value is exceeded. For reverse flow determination is based on absolute value.
FW-DRCT (forward flow)	:	Relay closed when there is flow in forward direction.
BW-DRCT (backward flow)	:	Relay closed when there is flow in backward direction.
HI-RNG (high range)	:	Relay closed when range status is high.
LO-RNG (low range)	:	Relay closed when range status is low.



[Totalized pulse width]

When FW INTG (forward flow totalized pulse output) or BW INTG (reverse flow totalized pulse output) is set as relay operation output, the width of the totalized pulse (i.e. time when the relay output is being created with the inverted output OFF) is set.

Totalized pulse width can be selected from the following.

20ms, 100ms, 500ms, 1000ms

Note

Carefully select totalized pulse width taking into consideration the totalized count up rate. Set the totalization unit so that the relationship between pulse width 'a' and pulse interval 'b' is  $a \leq b$ .

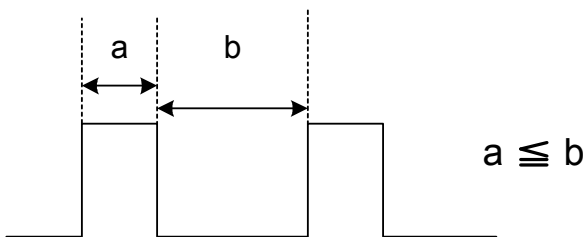

Pulse Width	Max. Output Rate
20ms	25 pulses/sec.
100ms	5 pulses/sec.
500ms	1 pulse/sec.
1000ms	1 pulse/2 sec.

Note

Totalized pulse is not an active output signal but a passive output signal as relay contact output..

[Setting of no receiving echo warning (ROFF ALARM)]

The relay output for no received signal warning for multi-path measurement can be set so that a warning is generated when all paths do not receive signals (AND) or if one of the paths does not receive a signal (OR).

[Logic inversion]

Relay logic can be inverted.

Independent ON/OFF settings can be made for each relay channel.

('a' relay operates at OFF, and 'b' relay operates at ON.)

## Confirmation of operational status

Operation of each function after data setting such as analog output, range fixing, and measurement path fixing and whether or not measurement is functioning properly can be checked.

### [Battery]

A letter '**B**' blinks at the upper portion of the measurement screen when remaining battery power is low.

Note1: When battery power is lost and power is shut off, totalized value cannot be retained.

Note2: When the battery is removed, the letter '**B**' does not appear in the display.

### [Measurement aberrations]

Check whether fault is due to no received signal or equipment failure.

- A letter '**R**' is displayed in the upper right of the measurement screen when there is no received signal.
- The number of 'No Received Signal' occurrences can be checked under "Status 2" of the measurement screen.

Note: The number of no received signal occurrences is retained in memory even when the power is turned off.

- In case of equipment failure, '**ERR\*\***' is displayed in the upper part of the measurement screen. The '**\*\***' suffix of the '**ERR**' indication identifies the source of the equipment failure. For details please see Table 4-1: Error Code Table under Chapter II-2-7, 'Output Operation During Measurement Aberrations'.

Note: The check display takes precedence during check operation. ('**ERR\*\***' is not displayed during the check operation.)

### [Detection of disturbance]

Momentary distortions in measurement values caused by bubbles or solids in the liquid are deleted.

- When disturbance of flow are detected, a '**D**' appears at the upper right of the measurement screen.
- The number of occurrences of disturbances detected can be checked under 'Status 2' of the measurement screen.

Note: The number of occurrences of disturbances detected is retained in memory even when the power is turned off.

### [High and low limit alarms]

Flow measurement values which exceed the upper limit setting or are less than the lower limit setting can be checked.

- When the upper and lower limits are exceeded, an '**O**' (alphabet '**O**') is displayed in the upper right of the measurement screen.
- Upper and lower limits can be set for forward flow and reverse flow respectively.
- Upper and lower limits are expressed as a 7-digit alphanumeric display which includes decimal point.
- The digit display and decimal point position is determined by the input expression of the forward max. flow value which is set via the analog output setting screen. For example, for forward max. flow value set at 500.00, the upper and lower limits can only be set to 2 decimal

positions. Value units are determined by the units of flow (unit and exponent).

#### [Checking forward and reverse flow changes]

Relay clatter caused by frequent forward and reverse flow changes can be suppressed to exceed a fixed period.

#### [Clearing of ROFF and DIS occurrences (log display)]

This function allows '0' reset of ROFF (no received signal) or DIS (obstruction detected) occurrences displayed under 'Status 2' of the measurement screen.

#### [Analog output check confirmation]

Analog output can be checked by inputting a percentage of max. flow value as set via the analog output setting screen.

- '**<A >**' is displayed at the upper part of the measurement screen when analog output is being checked.
- For double range setting, the value set as the high range max. flow should be considered 100%.

Note: When power is turned off the check function is cleared.

#### [Check of range fixation]

When the analog output pattern is set at double range, measurement can be carried out with the high and low ranges fixed. Current range status can be confirmed under the 'Status 1' on the measurement screen.

- When the range is fixed, an '**< R >**' is displayed at the upper part of the measurement screen.

Note: The check function continues even when the power is turned off.  
(Setting is retained in memory.)

#### [Check of path fixation]

When the measurement is set as multi-path, each path can be measured and display separately.

- When the path is fixed, an '**< M >**' is displayed at the upper part of the measurement screen.

Note: The check function continues even when the power is turned off.  
(Setting is retained in memory.)

#### [Acoustic velocities of fluids and Reynolds numbers]

Acoustic velocities of fluids and Reynolds' numbers of the measured fluid can be checked with the 'Basic Data' screen.

#### [Self-diagnostics]

This function checks for equipment failure. Failure diagnostics are performed on the transmitting, receiving, and time measurement circuits, etc., and the results are displayed. memory diagnostics is also performed during the setting of data. Diagnostics of totalizer memory is also performed when totalized values are being renewed.

Note: Self-diagnostics is continuously ongoing.

## Calibration

### [Correction of measurement values]

#### 1. Zero shift (Zero point correction)

Addition and subtraction to compensate for offsets in measurement values can be performed. Corrective value is a maximum, 7-digit alphanumeric including decimal point.

Displayed digits and decimal point position is determined by the input expression of the forward max. flow value which is set by the analog output setting screen similar to the upper and lower limit values. Value units are determined by the units of flow (units and exponent).

#### 2. Span correction

Measurement values can be corrected by an exponential coefficient.

Correction value (coefficient) can be set in the range  relative to each flow direction.

### [Low Cut (flow volume cutoff)]

When the measured flow value is less than the flow value setting, '0' flow can be imposed. The cutoff value is expressed with an alphanumeric of 7-digit max. length including the decimal point. Displayed digits and decimal point position are determined by the input expression of the forward max. flow value which is set by the analog output setting screen similar to the upper and lower limit values. Value units is determined by the units of flow (units and exponent).

### [Smoothing]

Flow is expressed at the time it takes to achieve 90% of measuring flow rate during stepped changes.

When flow measurement values fall into disarray, dampening can be enhanced by prolonging the smoothing time. Specifically, the response to flow changes is dulled.

Fixed units are in sec., and the setting range is  seconds.

### [AGC (automatic gain control)]

You can select whether to automatically correct for variances in received signal level. When automatic correction is selected, 'AGC' is displayed under 'Status 1' of the measurement screen.

#### Note:

This function is not normally used for reason that stable monitoring of received signal level cannot be achieved under certain conditions such as when bubbles are generated. Caution should be exercised as bubble formation often takes place when flow control valves are located close upstream.

## **Other**

### **[Setting of fault tolerance]**

Setting selection can be made to enable continuance of measurement ('ON') or discontinuance of measurement ('OFF') as long as measurement is enabled even if equipment malfunctions occur or when there is no received signal. Measurement is possible under the following conditions.

- In case of totalizer memory failure
- During multi-path measurement, in case one measurement path remains in operation when a malfunction or no received signal condition occurs with respect to other measurement paths.

Note1: See Fig. 4-4: Measurement Aberration Transition Diagram under Chapter II-2-7, 'Output Operating During Aberrations in Measurement'.

Note2: Although measurement accuracy is not affected by the tolerance function during memory failure, totalized values will be inconsistent.

Note3: When tolerance operation is activated during multi-path measurement, measurement accuracy will deteriorate.

Note4: Measurement will automatically recommence when a received signal is obtained even during no received signal processing.

### **[Digital output (RS232C output)]**

Measurement values of flow, etc., and status can be output via RS232C.

CH1 of the digital output (RS232C output) is a dedicated output port. The data output cycle can be changed. Fixed unit is sec., and the setting range is 0 to 3600 seconds.

CH2 of the digital output (RS232C output) is a bi-directional port. Connected to a PC, this port enables flowmeter setting by the PC and monitoring of measurement values, etc.

Baud rates for each channel can be selected from the following.

4800BPS, 9600BPS, 19200BPS
----------------------------

Note: Commissioning software is necessary for flowmeter setting with PC.

### **[Flowmeter, flow velocity measurement mode]**

By changing the measurement mode, the unit can be used as a flow velocity meter. Flow velocity values in the flow velocity meter mode are displayed as linear flow velocity values.

## II-2. Operation

This chapter provides information necessary for system operation, including layout of the operating unit, startup and shutdown procedures, screen navigation, and operating instructions.

<b>⚠ WARNING</b>
<ol style="list-style-type: none"> <li>1. Do not make the inner panel open when the equipment is working. High voltage parts causing electrical shock are inside.</li> <li>2. Do not take off a protective earth cable connecting front cover and enclosure.</li> <li>3. Do not take off a protective earth cable connecting panel cover and enclosure.</li> </ol>
<b>⚠ CAUTION</b>
Do not make the panel cover take off when the equipment is working.

### Note

Measurement operation continues during data setting (MENU/INPUT) and check (MENU/CHECK) procedures.

Measurement values during operation may change when settings are changed.

### II-2-1. Main operating (electronics) unit layout

Unfasten the right side clasp of the unit enclosure and open the cover to the left. The layout of major components is as shown below.

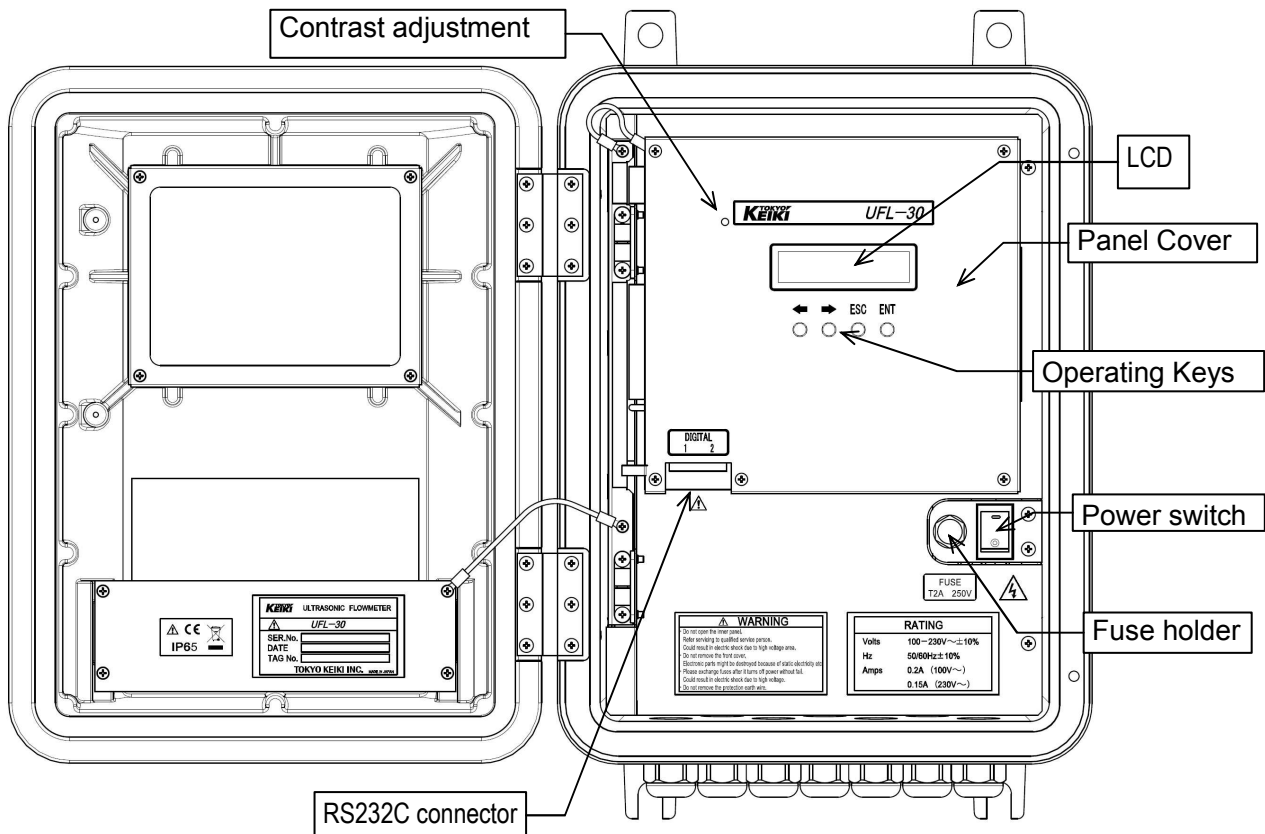

Fig. 2-2-1; Case Interior  
(may differ according to specification)

## II-2-2 Startup and shutdown procedure

### (1) Startup

- Turn power switch ON.  
If system setting is complete, system will run through self-diagnostics and automatically commence measurement.

### (2) Shutdown

- Turn power switch OFF.  
Data, totalized values, etc., which are required for measurement will be retained in non-volatile memory and in battery-powered back-up memory when the system is shutdown.

## II-2-3 LCD and operating keys

Fig. 4-2: LCD and operating key layout

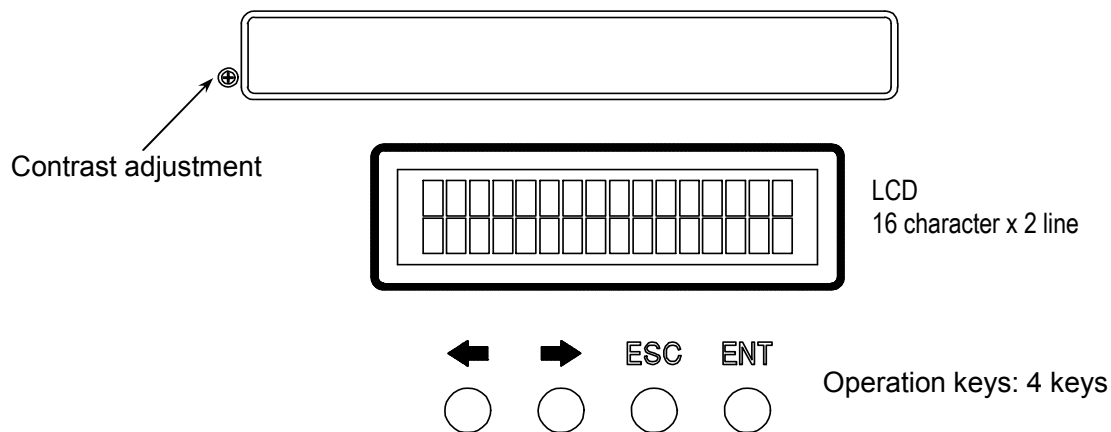

### Operating keys

#### Measurement screen

- ◀▶ key: On the flow screen, switches flow values for each measurement path
- ENT key: Changes measurement screen  
(Flow → Flow Velocity → Integration(Totalize) → Status 1 → Status 2)
- ESC key: Changes to Flow Measurement screen

#### Menu screen

- ◀▶ key: Used for item selection
- ENT key: Enters selection
- ESC key: Cancels selection

#### Numerical input screen

- ◀▶ key: Increases or decreases numerical values
- ENT key: Moves numerical digit to be changed to the right  
This key at Far-right number determines changed number.
- ESC key: Moves numerical digit to be changed to the left.  
It returns number to previous value by this key at the Far-left number position.

### Contrast adjustment

Contrast of the LCD display can be adjusted with a Phillips-head screwdriver.

## II-2-4 Display layout and description

### II-2-4-1 Measurement display

#### Flow Volume Display

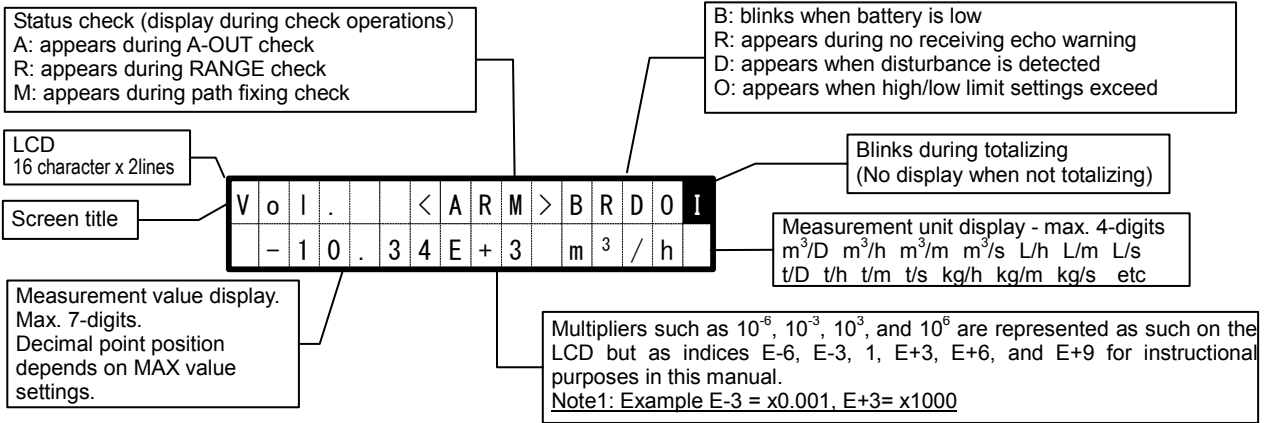

#### Flow Velocity Display

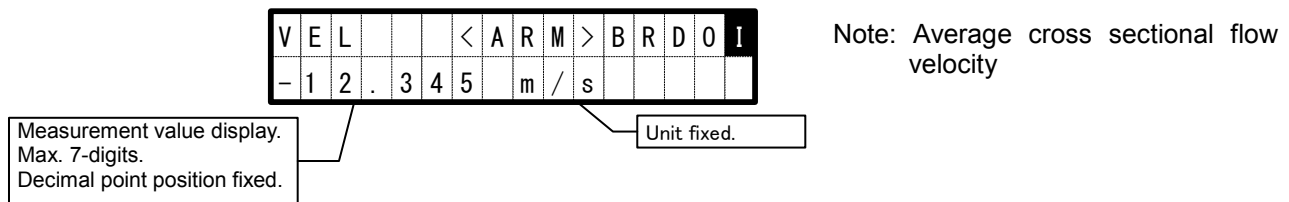

#### Totalizing Display

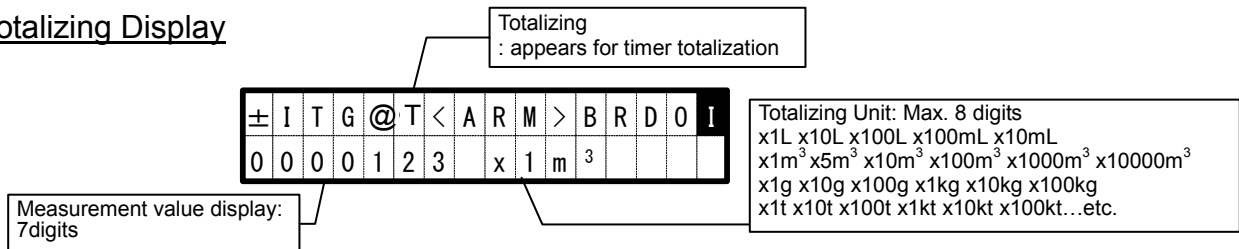

#### Status 1

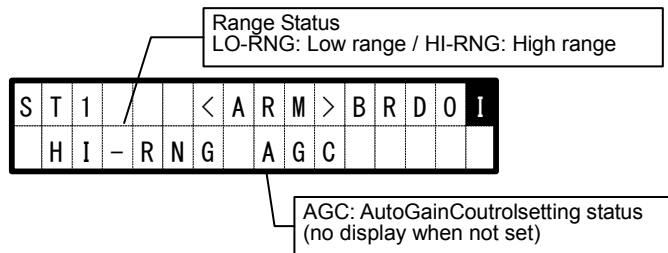

#### Status 2

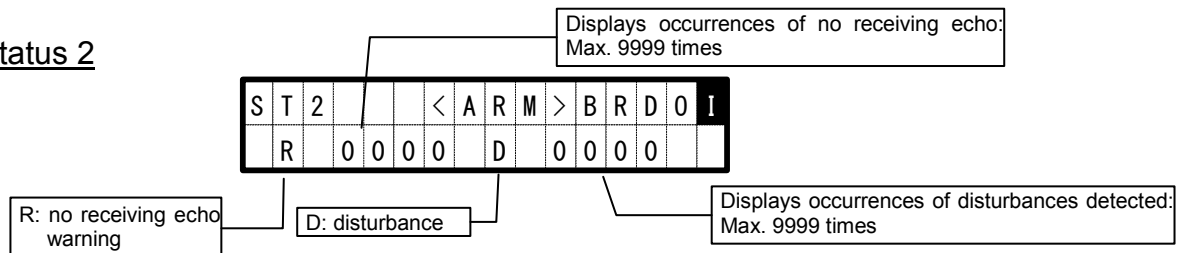



## II-2-4-2 Menu screen

### Top Menu

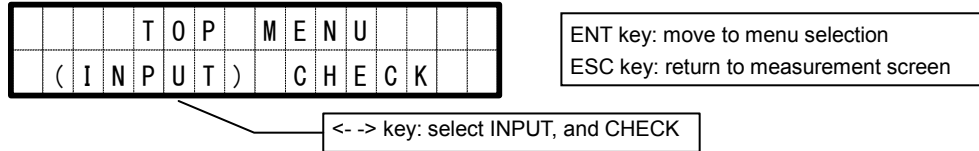

### Setting Menu

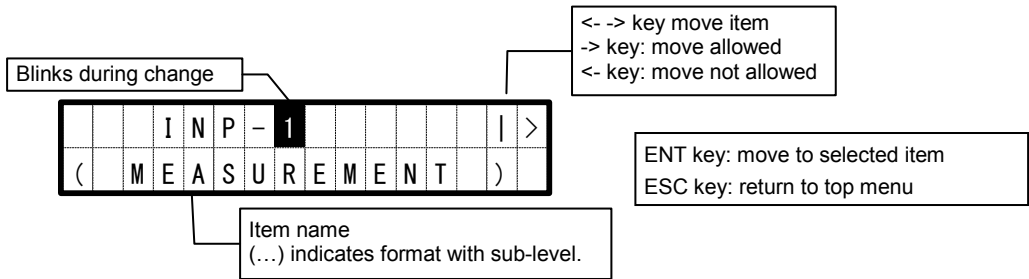

### Menu Selection

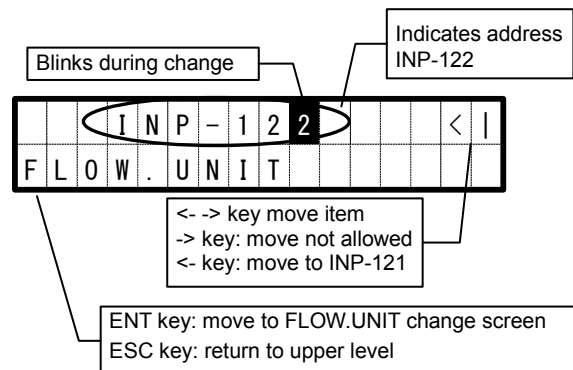
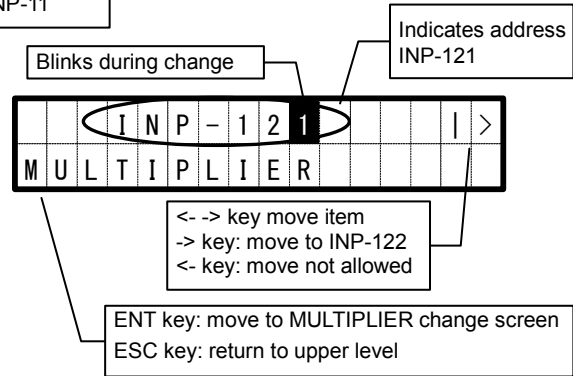
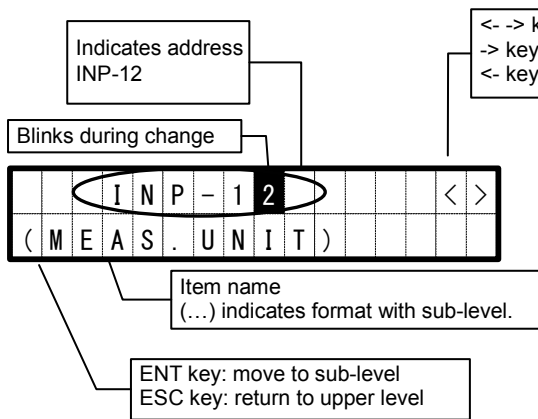
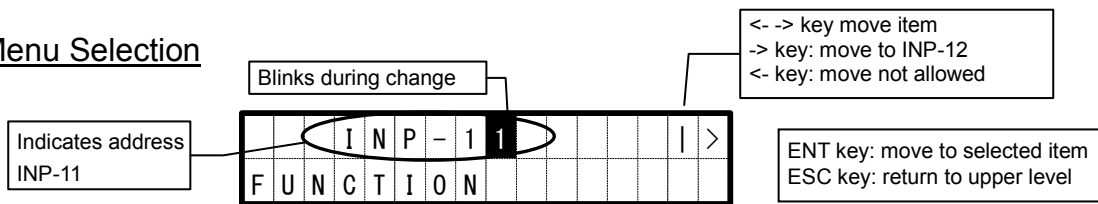

## II-2-5 Menu Overview in LCD

Fig. 4-3 ; Summary of LCD Operation

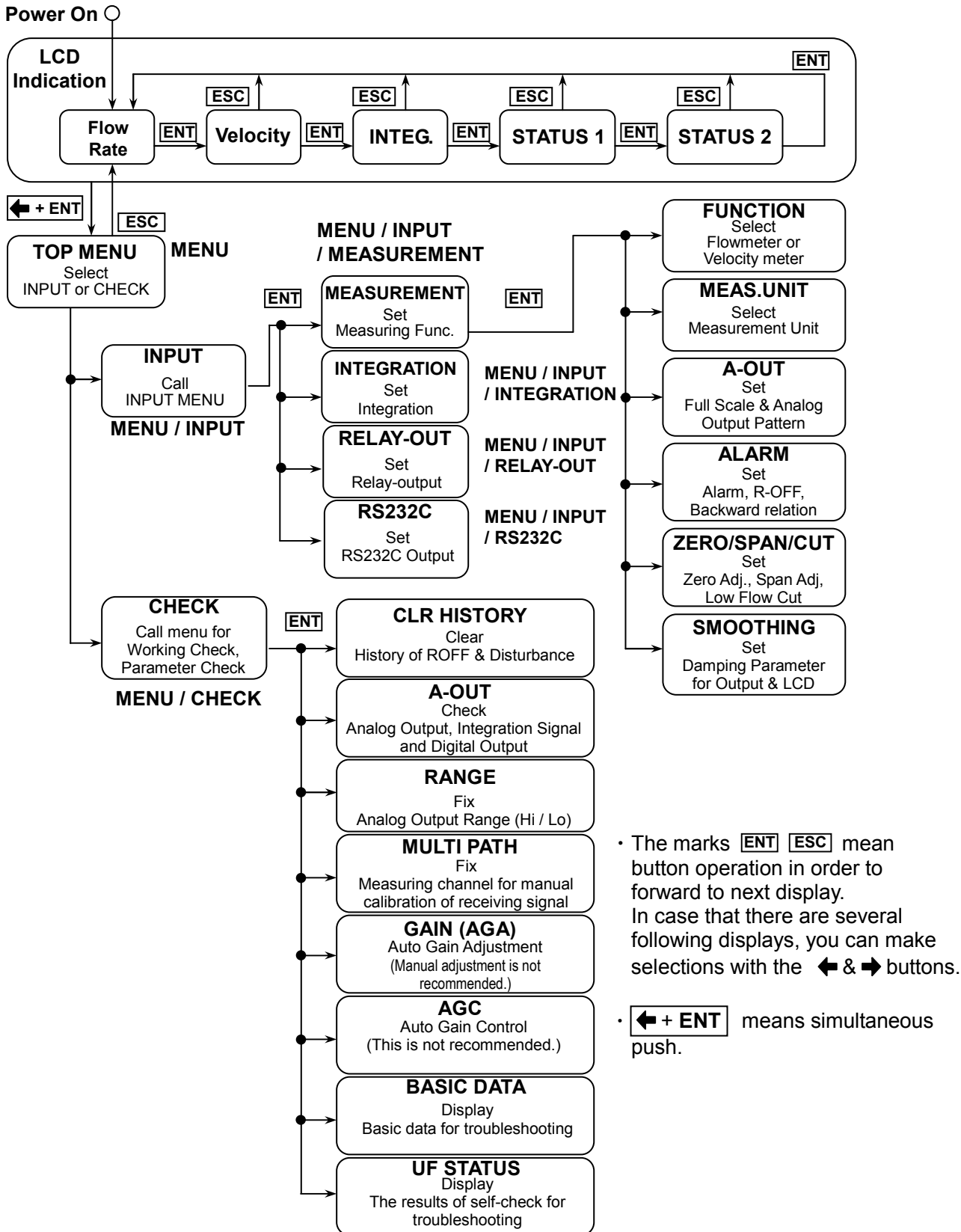

## II-2-6 How to operate, Function by Function (LCD operation & PC operation)

This section provides a description of operation in accordance with each function that you would like to setup. Please refer to paragraph II-1 “Functions”.

Each menu and parameter has an I.D. address in the memory as described below.

[Address: menu item]

- The first address [ INP-1□□ ], this category can be reached from the menu of “MEASUREMENT” menu.
- The first address [ INP-2□□ ], this category can be reached from the menu of “INTEGRATION” menu.
- The first address [ INP-3□□ ], this category can be reached from the menu of “RELAY-OUT” menu.
- The first address [ INP-4□□ ], this category can be reached from the menu of “RS232C” menu.
- The first address [ CHK ], this category can be reached from the menu of “CHECK” menu.

About using the commissioning software, please refer to the chapter I-2-13.

### < Open “TOP MENU” >

In order to open “TOP MENU”, please push the **←** button and the **ENT** button simultaneously at any indication. Pushing the **ESC** button allows return to the previous display (ex. [Flow Rate] Display).

### < Open “INPUT” menu >

In order to open “INPUT”, please select “INPUT” and push the **ENT** button at “TOP MENU”.

Use the **←** & **→** buttons to select submenu (“MEASUREMENT”, “INTEGRATION”, “RELAY-OUT”, and “RS232C”) and push the **ENT** button to open the selected submenu.

### < Open “CHECK” menu >

In order to open “CHECK”, please select “CHECK” and push the **ENT** button at “TOP MENU”.

## (1) LCD Display Relation

### a. Change indicating options on the display

Default indication is [Flow Rate]. Whenever the **ENT** button is pushed, the indication will be replaced as follows. The **ESC** button returns the indication to [Flow Rate].

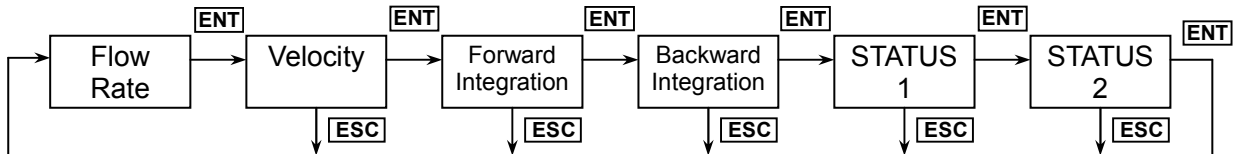

- \* [Backward Integration] can be displayed in the case of bi-directional analog output only.
- \* The flowmeter resumes showing the last indication when the power was shut off.
- \* This display can individually indicate flow rate at every measuring path during multi-path measuring mode.

Vo l . < A R M > B R D 0 I  
- 1 0 . 3 4 E + 3 m<sup>3</sup> / h

ex) [Averaged Flow Rate] is indicated by multi-path measurement.

The **←** & **→** buttons select individual flow rate for every measuring path.

\*1

P A T H 1 < A R M > B R D I  
- 1 0 . 3 4 E + 3 m<sup>3</sup> / h

P A T H 2 < A R M > B R D I  
- 1 0 . 3 4 E + 3 m<sup>3</sup> / h

P A T H 3 < A R M > B R D I  
- 1 0 . 3 4 E + 3 m<sup>3</sup> / h

P A T H 4 < A R M > B R D I  
- 1 0 . 3 4 E + 3 m<sup>3</sup> / h

Push the **←** & **→** buttons to select the number of the measuring path.

\*1 [O] = Sign of Over Range  
This can be indicated during [Averaged Flow Rate] mode.

The **ESC** button returns the indication to [Averaged Flow Rate] from [Individual Flow Rate] indication.

## (2) Flow Measurement Relation

### a. Change measuring unit

Display Menu No. : INP-121 : MULTIPLIER

Display Menu No. : INP-122 : FLOW UNIT

Multiplier Options :  $\times 10^{-6}$ ,  $\times 10^{-3}$ ,  $\times 1$ ,  $\times 10^{+3}$ ,  $\times 10^{+6}$ ,  $\times 10^{+9}$

Measuring Unit Options :  $\text{m}^3/\text{D}$ ,  $\text{m}^3/\text{h}$ ,  $\text{m}^3/\text{min}$ ,  $\text{m}^3/\text{s}$ , L/h, L/min, L/s, t/D, t/h, t/min, t/s, kg/h, kg/min, kg/s, Mft<sup>3</sup>/D, ft<sup>3</sup>/D, ft<sup>3</sup>/h, ft<sup>3</sup>/min, ft<sup>3</sup>/s, Mgal/D, gal/D, gal/h, gal/min, gal/s, Mbbbl/D, bbl/D, bbl/h, bbl/min, bbl/s, Macf/D, acf/D, acf/h, acf/min, acf/s

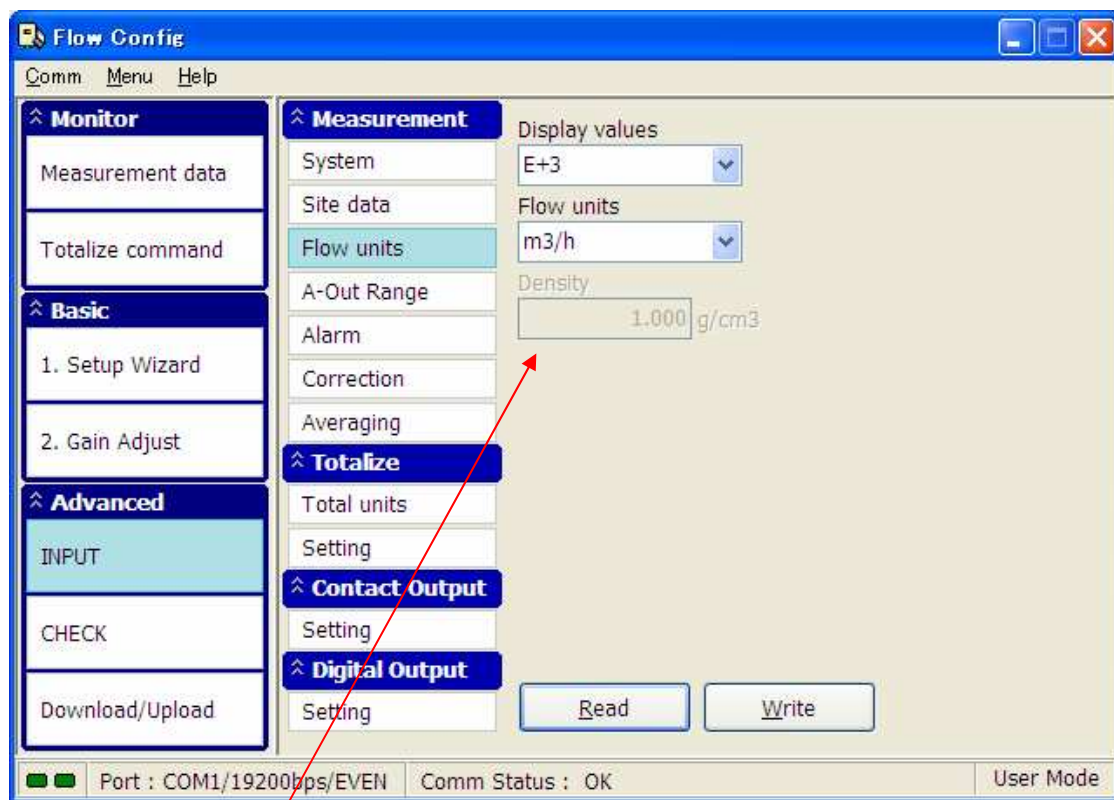

### Use mass unit

In case of using mass unit (ex. kg/h etc.), it is necessary to input the liquid density, as follows.

### b. Change fluid density

Display Menu No. : INP-123 : DENSITY

Initial value : 1.000

Range of Input : 0.100 to 9.000

This parameter shall be required in case that Mass Unit (t, kg) is selected in the menu INP-122 : FLOW UNIT.

**c. Set High / Low Alarm**

Display Menu No.	Menu Item	Detail of Data	Range of Value
INP-1451	LIMIT ALARM	On / Off	-
INP-1452	+UPPER LIMIT	Upper Limit Value for Forward Flow	0.000 to 99999.0
INP-1453	+LOWER LIMIT	Lower Limit Value for Forward Flow	0.000 to 99999.0
INP-1454	-UPPER LIMIT	Upper Limit Value for Backward Flow	-99999 to 0.000
INP-1455	-LOWER LIMIT	Lower Limit Value for Backward Flow	-99999 to 0.000

Note :

In case of input into “-UPPER LIMIT” or “-LOWER LIMIT”, the character at the left-end in the LCD can be a “blank” or “minus”.

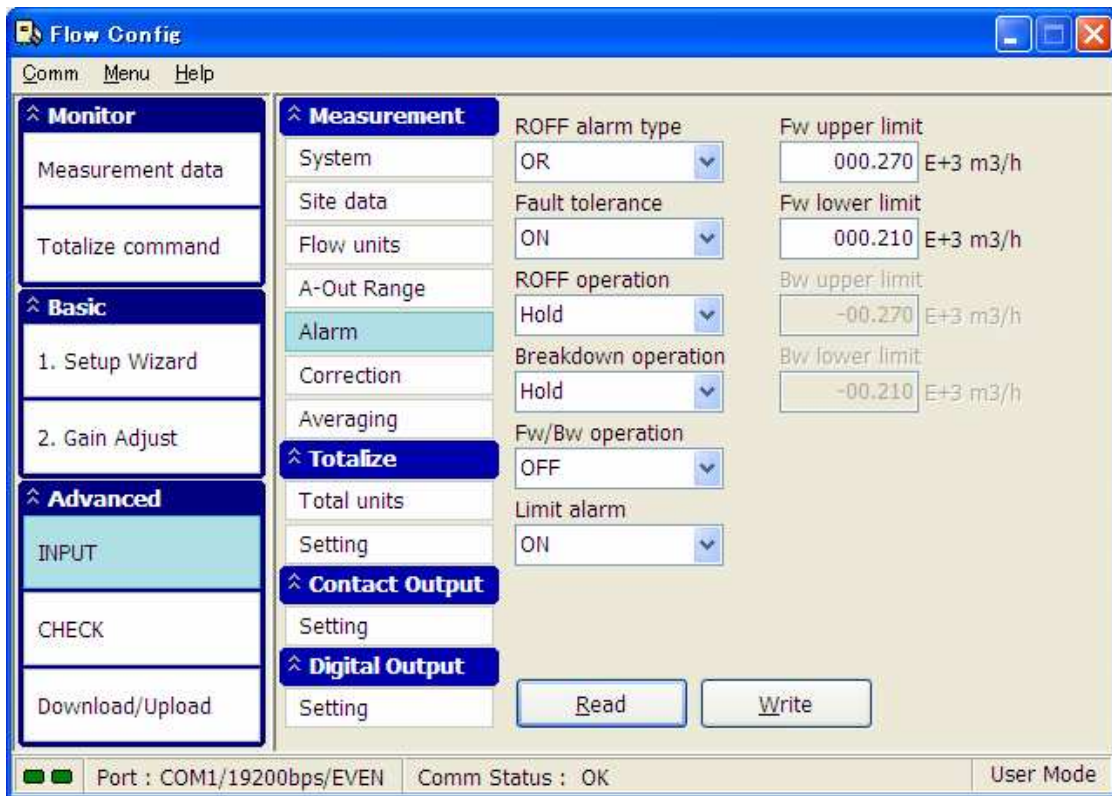

**d. Prevent frequent changeover between Forward measuring and Backward measuring during low flow situation**

d-1 Turn on the function “Forward / Backward Operation”

Display Menu No. : INP-146 : FW/BW OPE.

Initial value : “ 0: OFF ”

d-2 Set the function “Low Flow Cut”

Display Menu No. : INP-153 : +LOW CUT

: INP-156 : -LOW CUT

Individually setup  
both Forward and Backward

Initial value : 1.5% of Full Scale or User defined value

Range of Input : +LOW CUT : 0.000 to 9999.00

: -LOW CUT : -9999.0 to 0.000

Flow Rate Unit : According to Measuring Unit that was set in  
INP-121 : MULTIPLIER & INP-122 : FLOW UNIT.

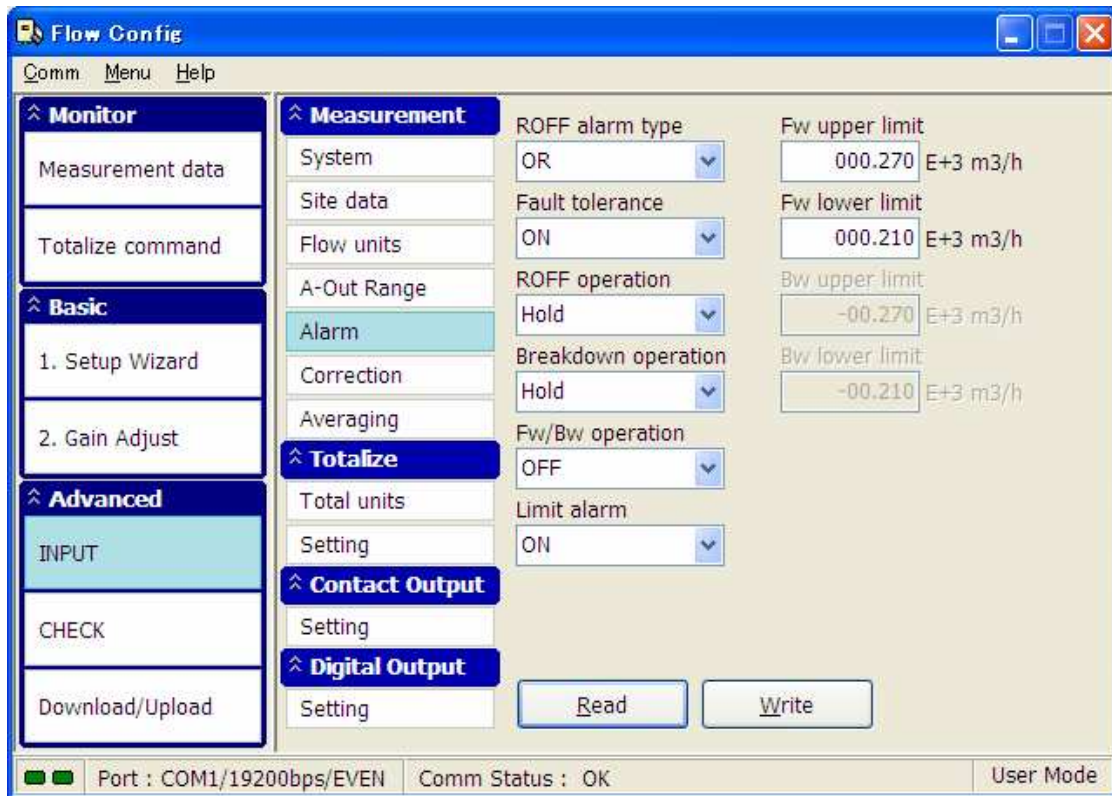

**Note :**

In case of input into “-LOW CUT”, the character at the left-end in the LCD can be a “blank” or “minus”.

**e. Adjust measured value**

**e-1 Zero Shift**

Display Menu No. : INP-151 : +ZERO SHIFT  
 : INP-154 : -ZERO SHIFT

Individually setup both Forward and Backward

Range of Input : +ZERO SHIFT : -9999.0 to 9999.0  
 : -ZERO SHIFT : -9999.0 to 9999.0

Flow Rate Unit : According to Measuring Unit that was set in  
INP-121 : MULTIPLIER & INP-122 : FLOW UNIT.

**Note :**

In case of input into “-LOW CUT”, the character at the left-end in the LCD can be a “blank” or “minus”.

**e-2 Span Correction**

Display Menu No. : INP-152 : +SPAN CORR.  
 : INP-155 : -SPAN CORR.

Individually setup both Forward and Backward

Initial value : “ 1.000 ”

Range of Input : 0.100 to 2.000

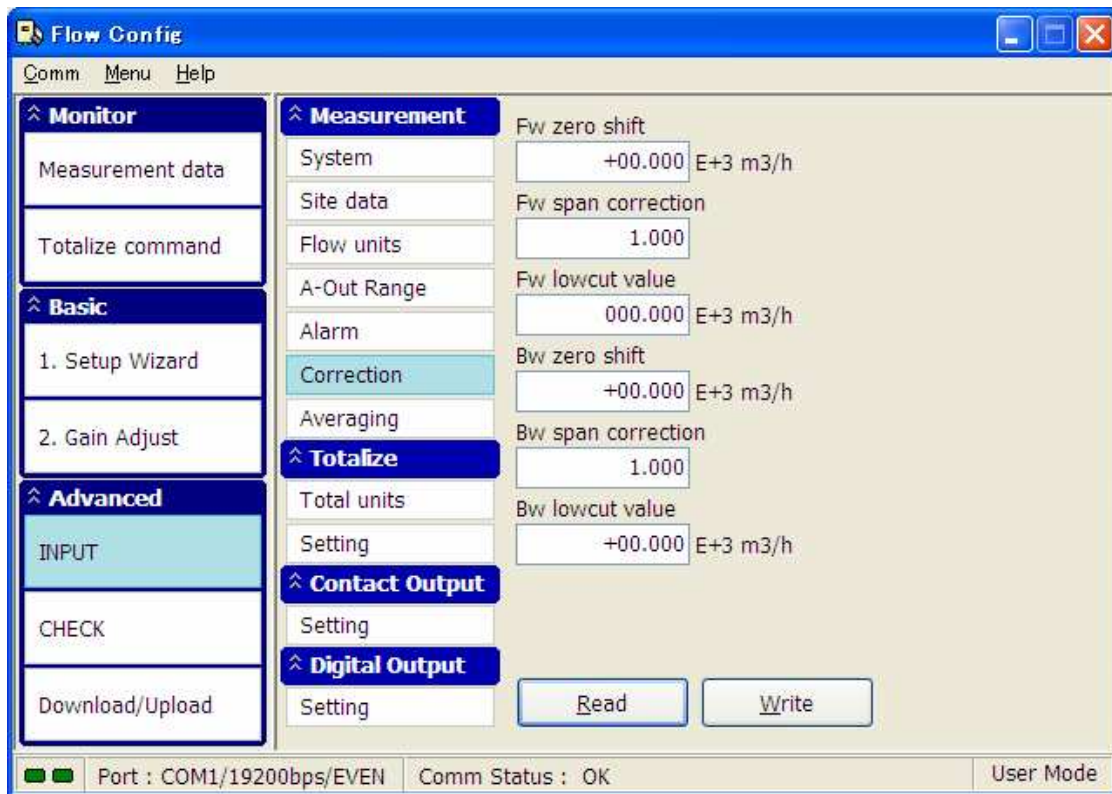

**f. ampen Output fluctuation (Change Smoothing parameter)**

Display Menu No. : INP-16 : SMOOTHING

Initial value : " 015 sec. "

Range of Input : 0 to 120 (sec.)

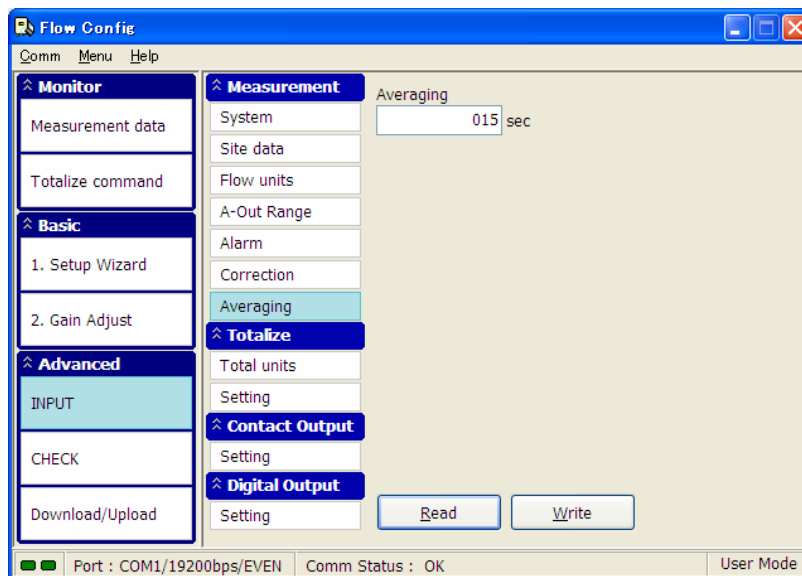

Note :

This value means the time until measuring flow rate reaches 90% by step-up increment. If the time is extended close to 120 sec., the output will be dampened well against fluctuation. (The output response against fluctuation will be inertial.)

**(3) Analog Output relation (4-20mA Current Output)**

**a. Change output pattern (4-20mA current output pattern)**

Display Menu No. : INP-131 : A-OUT TYPE

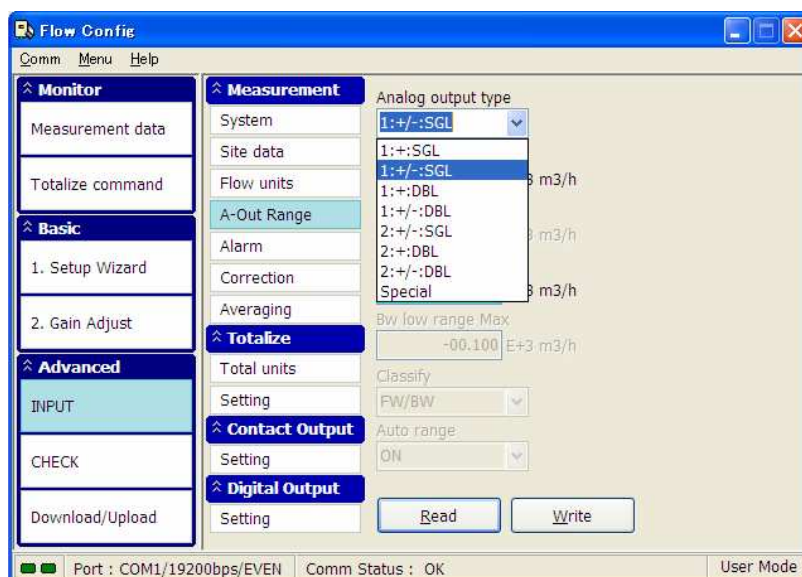

Note :

Regarding the details of each pattern, refer to "Chapter III-2-5 Table 1; Analog Output Profile".



**b. Change digits of flow rate display and/or measuring range**

Display Menu No. : INP-132 : +MAX VALUE

The number of maximum characters on the LCD and the position of the decimal point will be arranged according to the parameter, Maximum Flow Rate (Forward).

The maximum number of characters on LCD is 7 characters including “ - “ mark & a decimal point.

(Provided that maximum range of flow rate is 99999.0 regardless of measuring unit.)

Each function of High/Low Alarm, Zero Shift and Low Flow Cut will be also in accordance with same condition.

Note :

**It can be set to four decimal places. The fifth decimal place is not available.**

Analog Output Pattern		Display Menu No. for Measuring Range	Range of Value
Single Range		INP-132 : +MAX VALUE	0.001 to 99999.0
		INP-134 : -MAX VALUE	-99999 to -0.001
Double Range	High Range	INP-132 : +MAX VALUE	0.001 to 99999.0
		INP-134 : -MAX VALUE	-99999 to -0.001
	Low Range	INP-133 : +LOW VALUE	0.001 to 99999.0
		INP-135 : -LOW VALUE	-99999 to -0.001

**Flow Rate Unit**

According to Measuring Unit that was set in INP-121 : MULTIPLIER & INP-122 : FLOW UNIT.

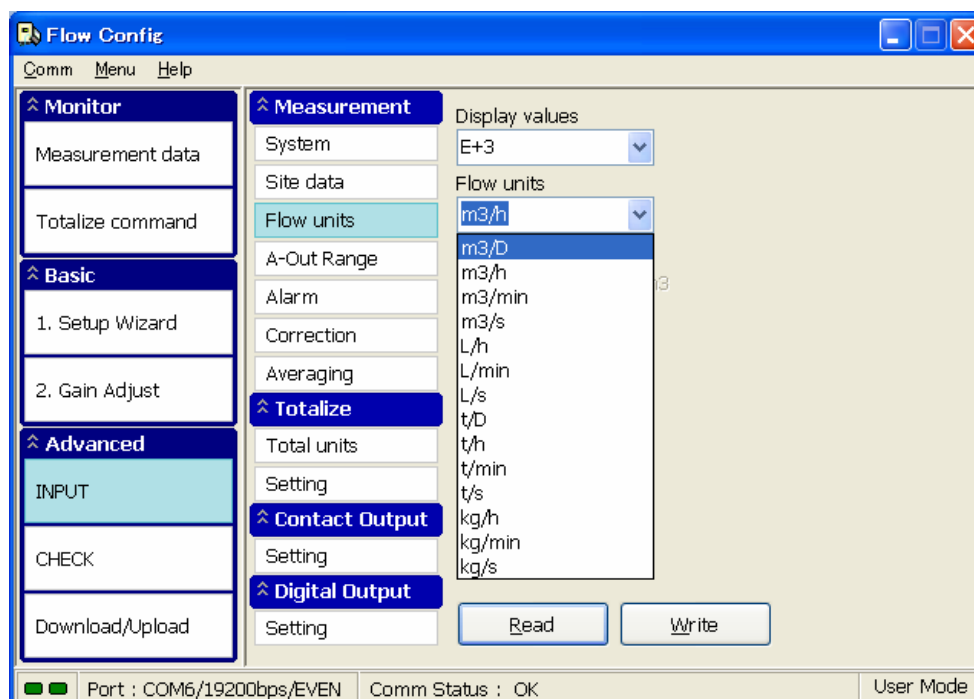

Note :

The decimal place is according to the parameter of INP-132 : +MAX VALUE.

The character at the left-end in the LCD can be a “blank” or “minus”.

**c. Determining flow direction or High/Low ranges**

Display Menu No. : INP-136 : CLASSIFY  
 Initial value : "0 : FW/BW" (flow direction).

This parameter is required if analog output profile "2:+/-:DBL" is selected for parameter, INP-131: A-OUT TYPE..

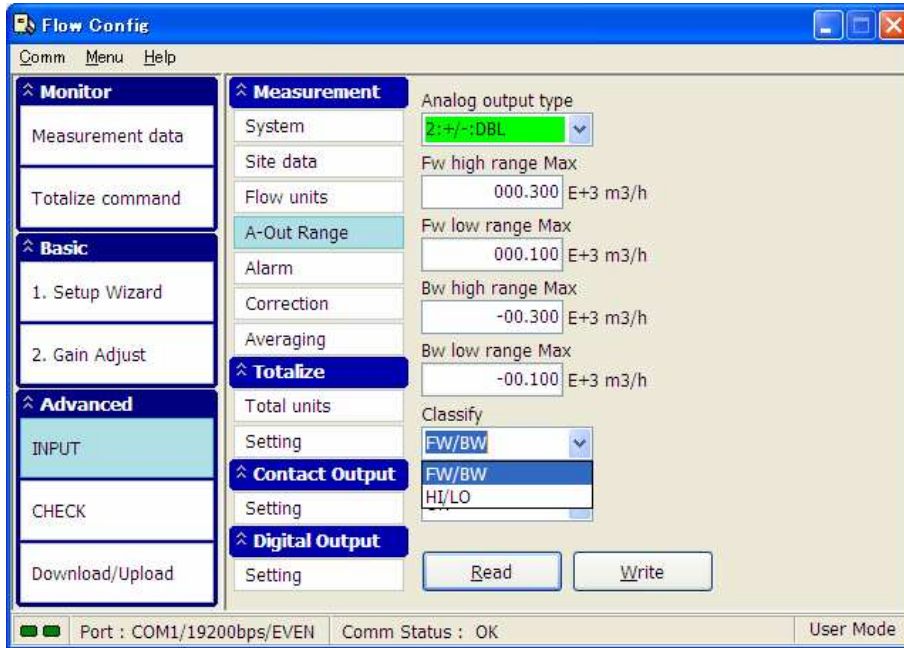

**d. Changing the On/Off Range switching method for double range (Set manual range switching)**

Display Menu No. : INP-137 : AUTO HI/LO  
 Initial value : "1 : ON" (Automatic switching).

**"Note: Do not select "O: OFF" to conform to CE marking declaration.**

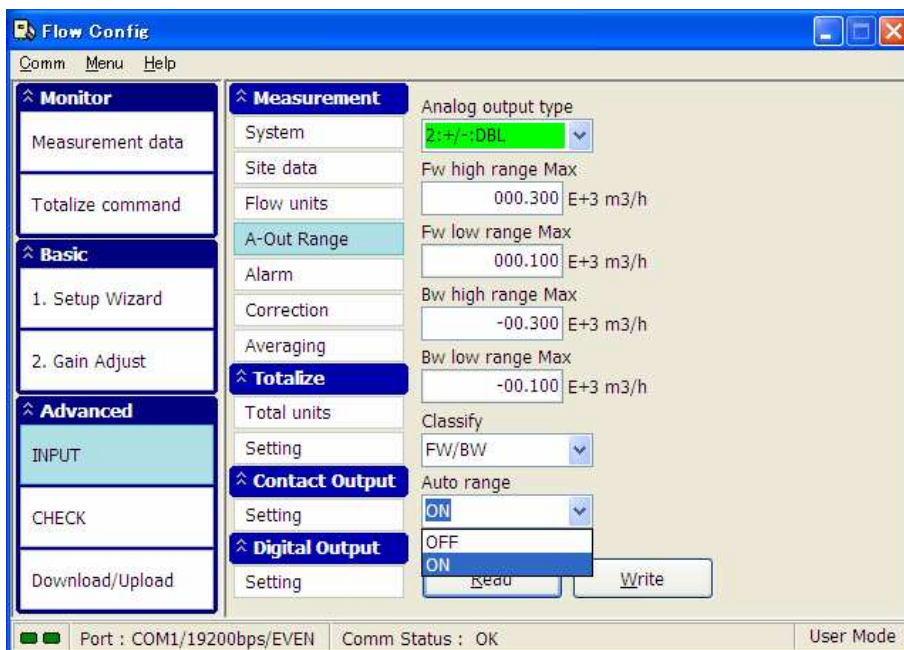

**e. No receiving echo (ROFF ALARM) setting**

Display Menu No. : INP-141 : ROFF ALARM

Initial value : "0\* OR" (no receiving echo from ANY path)

"1: AND" = no receiving echo from ALL paths

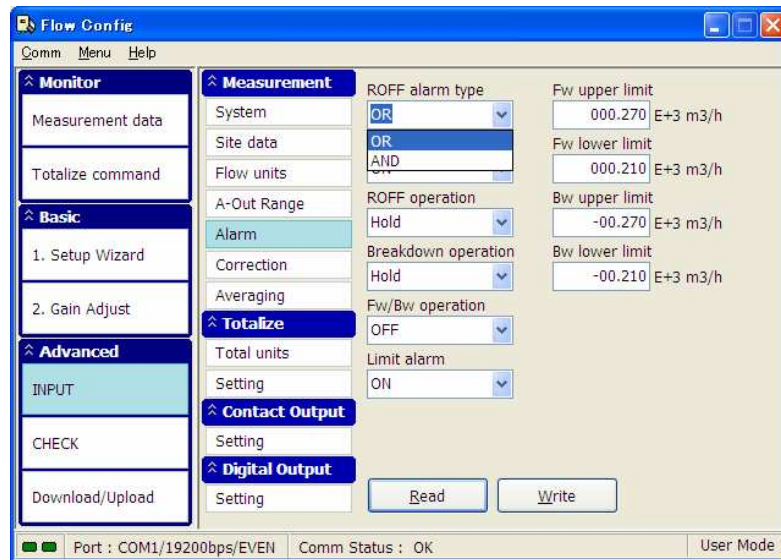

**f. Fault tolerance setting**

Display Menu No. : INP-142 : FAULT TOLERANCE

Initial value : "1:ON" (measurement continues as long as possible)

"0: OFF" = unconditionally halts measurement when readings are not correct (i.e. are not within normal limits).

In case of ROFF (no receiving echo) or hardware (breakdown) problem during multi-path measurement, output will be according to parameter, INP-143: ROFF A-OUT OPE.

In the case of a hardware (breakdown) only problem occurring during multi-path measurement, output will be according to parameter, INP-144: B.D. A-OUT OPE.

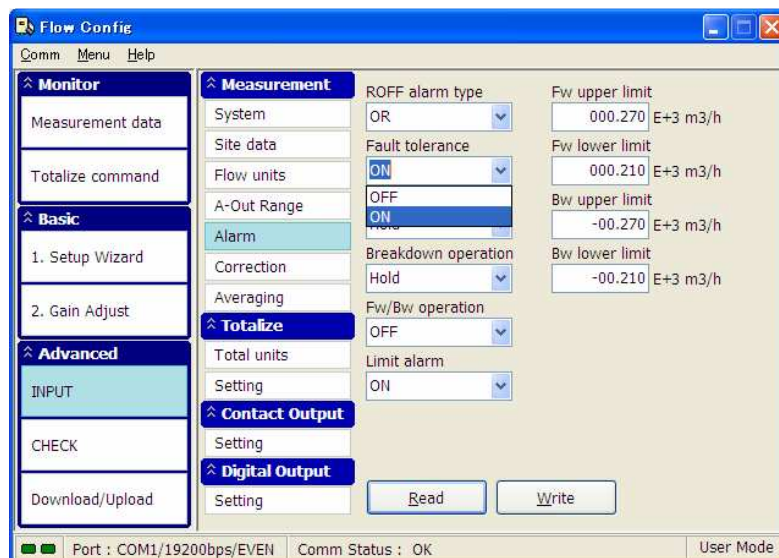

Please refer to Chapter II-2-7 "Output operating during Aberrations in Measurement" .

**g. Changing analog output operation during ROFF (no receiving echo)**

Display Menu No. : INP-143 : ROFF A-OUT OPE.

Initial value : "1 : HOLD"

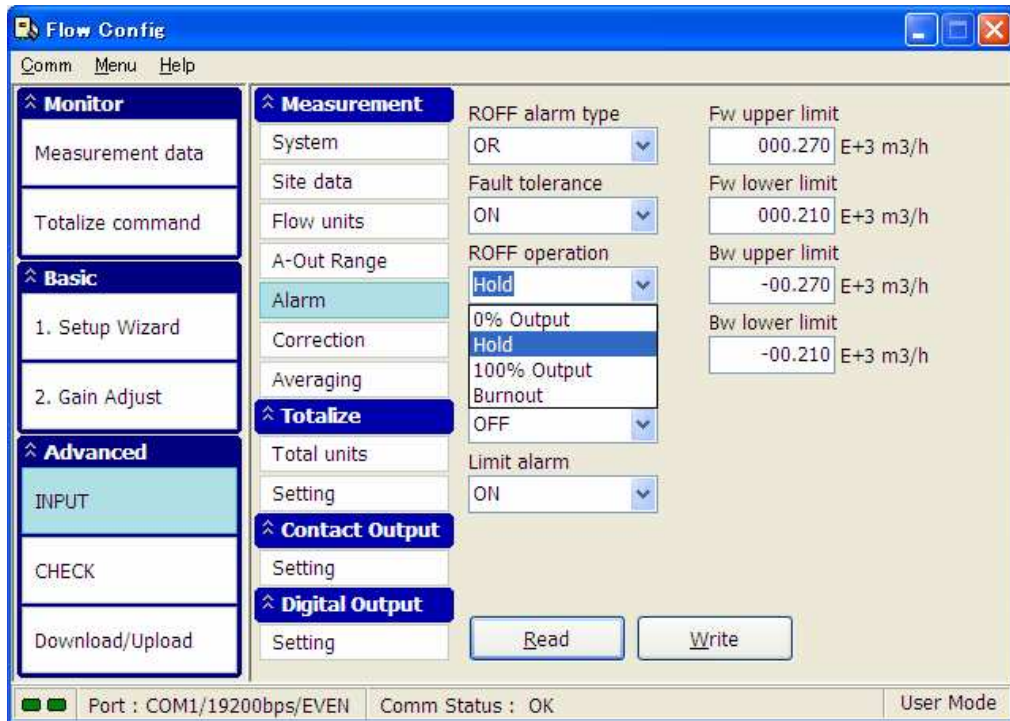

**h. Changing analog output operation during Break Down (B.D.)**

Display Menu No. : INP-144 : B.D. A-OUT OPE.

Initial value : "1 : HOLD"

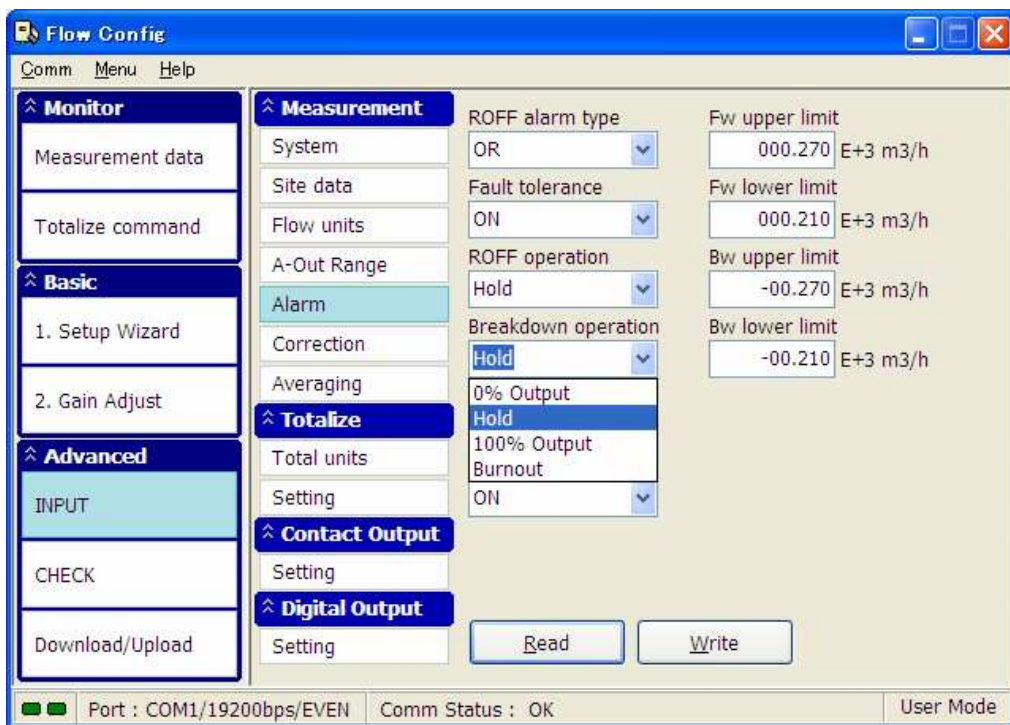

#### (4) Integration (Totalizing) Function

**a. Changing totalizing unit**

Display Menu No. : INP-211 : +ITG.UNIT  
INP-212 : -ITG.UNIT } Individually set up for both forward and backward modes

Initial value : "0 : NONE" (no integration)

For mass units (i.e. kg, t, etc.), the mass flow rate unit (i.e. kg/h, t/min., etc.) must be selected prior to selecting the totalizing unit under parameter, INP-122: FLOW UNIT.

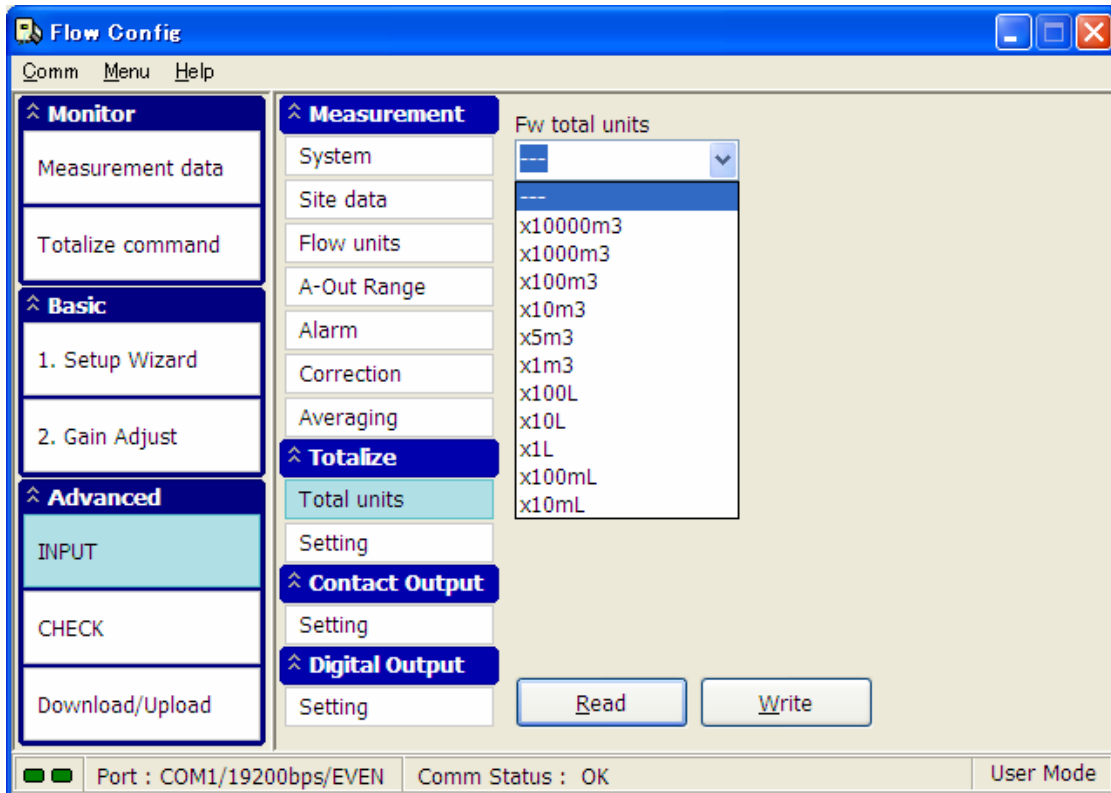

**b. Totalizing start and end**

Display Menu No. : INP-221 : STOP MODE  
 Initial value : "0 : MANUAL" (Continuous Integration)

Display Menu No.	Function
INP-222 : [START]	Integration Start
INP-223 : [PRESET START]	Integrating start from input value (refer to (4)-c)
INP-224 : [STOP]	Integration Stop
INP-225 : TIMER	Integrating during input time, automatic stop. Range of values: 00h00m00s to 99h59m059s.

When the totalizing function is active, the reverse field of the "I" mark blinks at the far right of the 1<sup>st</sup> line of the display, except during [STATUS 1] or [STATUS 2] display. The "I" mark disappears when the totalizing function stops.

Note: The blinking cursor shifts through an hours, minutes, and seconds ("h", "m", and "s") time sequence.

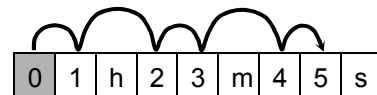

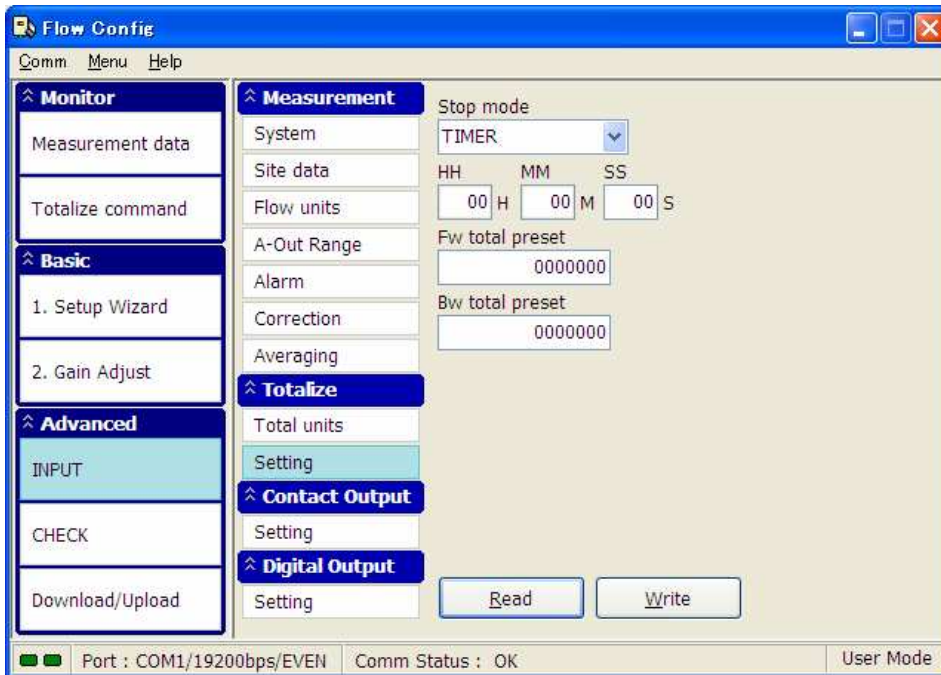

**c. Presetting totalizing start value**

Initial value : "0000000"  
 Range of value : 0 to 9999999

Display Menu No.	Function
INP-231 : +ITG.PRESET	Preset starting value for forward flow integration
INP-232 : -ITG.PRESET	Preset starting value for backward flow integration
INP-223 : [PRESET START]	Integration starts from preset value.

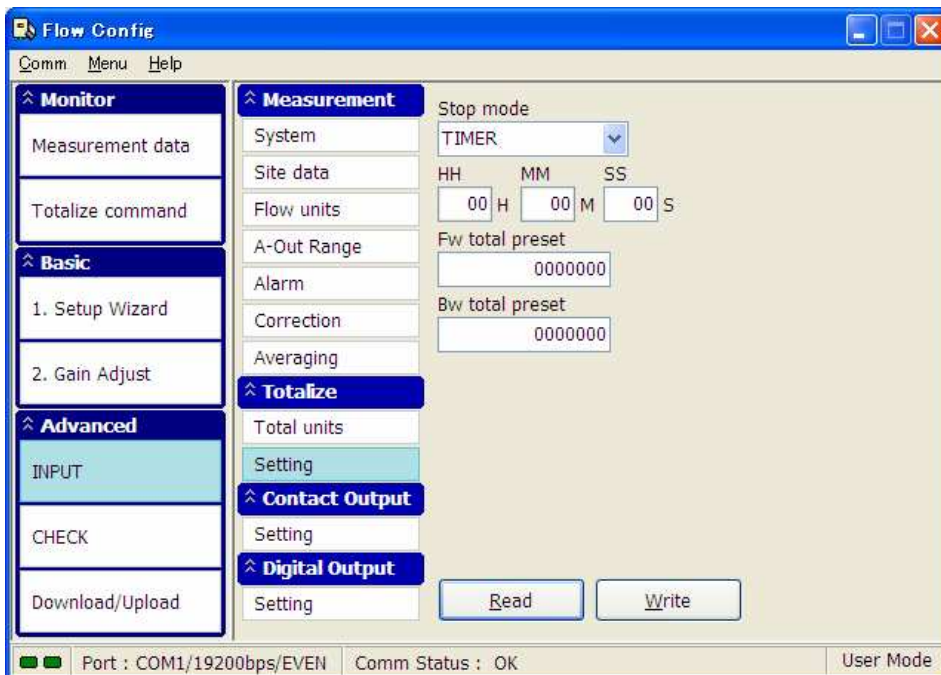

Note:

In case of "INP-223: [START]", totalizing continues from the present indicated value.

## (5) Contact (Relay) Output Function

### a. Contact (Relay) output menu and initial value

Display Menu No. : INP-311 : RELAY#1 PARAM  
 INP-312 : RELAY#2 PARAM  
 INP-313 : RELAY#3 PARAM  
 INP-314 : RELAY#4 PARAM

Initial value : "0 : BREAK" (no output)

Individually set up

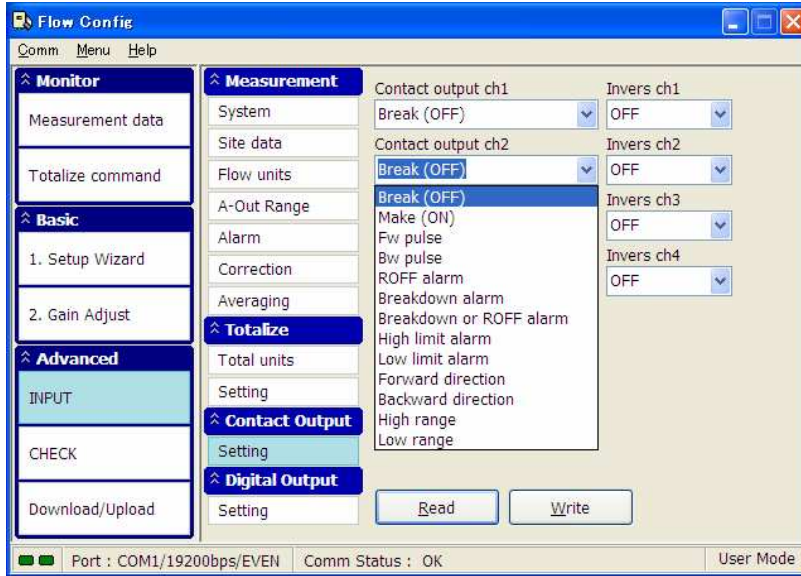

### b. Change totalizing output pulse width

Display Menu No. : INP-32:INTEG PULSE  
 Initial value : "1 : 100ms"

To utilize totalizing pulse output, select "FW INTEG" or "BW INTEG" under menu parameters INP-311: RELAY#1 PARAM . . . INP-314: RELAY#4 PARAM.

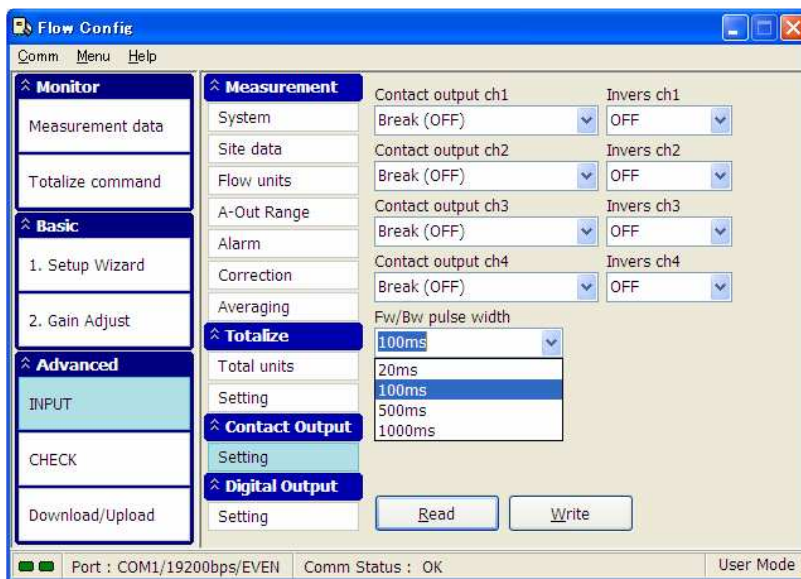

**c. Switching contact method, open or closed (make-contact or break-contact)**

Display Menu No. : INP-331 : RELAY#1 INVERS  
INP-332 : RELAY#2 INVERS  
INP-333 : RELAY#3 INVERS  
INP-334 : RELAY#4 INVERS

Individually set up

Initial value : "0 : OFF" (make-contact output, normal open)

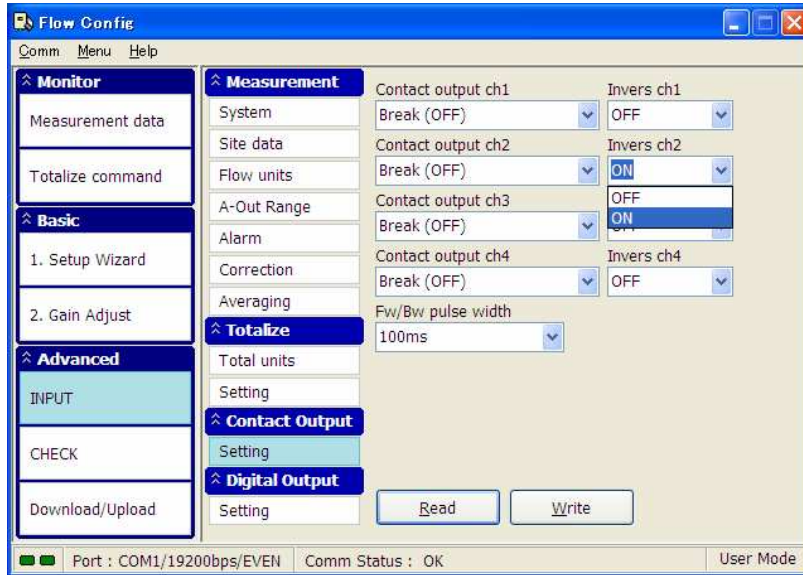



**(6) Digital Output Function (RS-232C)**

**a. Changing Baud Rate of RS232C output**

Display Menu No. : INP-421 : BAUD RATE#1  
 INP-422 : BAUD RATE#2  
 Initial value : BAUD RATE#1 = "9600BPS"  
 BAUD RATE#2 = "19200BPS"

**b. Downloading parameters to a personal computer (PC)**

A PC can be connected to port#2 using an RJ-45 connector to download setting parameters.

**c. Changing parameters with a personal computer (PC)**

Setting parameters can be changed with the PC by connecting it to port#2 with an RJ-45 connector. Please refer to Chapter I-2-9, "Input Parameters with commissioning software."

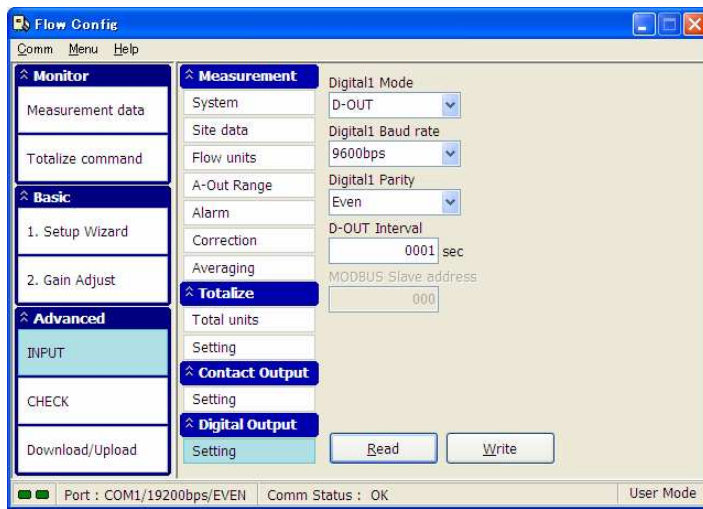

**(7) Check Function**

**a. Clearing the repetition counter (history) for ROFF [R] (no receiving echo) and Disturbance [D] (flow measurement disturbances)**

Display Menu No. : CHK-1 : [CLR HISTORY]  
 This counter is monitored with the [STATUS 2] display.  
 Select [YES] with the ENT button to reset both numbers to zero.

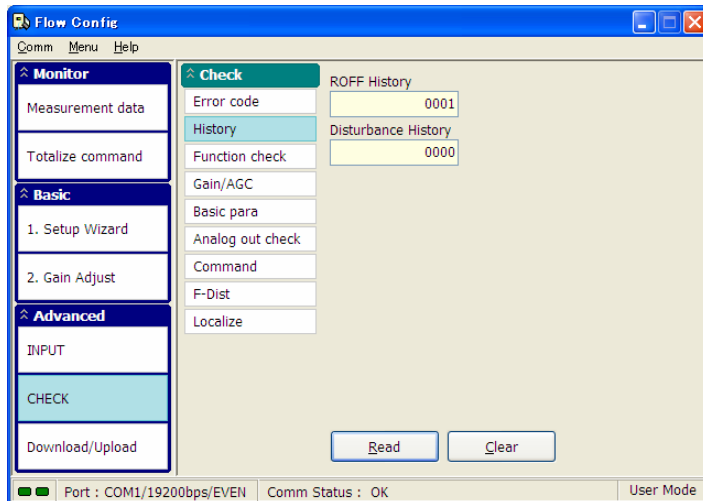

**b. Checking analog output (4-20mA current output)**

Display Menu No. : CHK-21 : RATIO  
 Range of Value : -120.0 to +120.0

In order to set any output current, you need to input a percentage of full scale flow rate. If "SPAN CORR" and/or "LOW CUT" functions are activated, output current shall be in accordance with these adjustments.

**Double Range**

Please refer to the analog output profile in the graph at right.

ex.) Forward Max. Flow Rate = "0.4"  
 Forward Max. Flow Rate in Low Range = "0.1"  
 CHK-21 : RATIO = less than "+22.5%" = Low Range  
 ( $0.4 \times 0.225 = 0.09 \leq 0.100 \times 0.9$ )  
 CHK-21 : RATIO = more than "+22.6%" = High Range  
 ( $0.4 \times 0.226 = 0.0904 > 0.100 \times 0.9$ )

\* In case range change from High to Low,  
 CHK-21 : RATIO = less than "+20.1%" = High Range  
 ( $0.4 \times 0.201 = 0.0804 > 0.100 \times 0.8$ )  
 CHK-21 : RATIO = more than "+20.0%" = Low Range  
 ( $0.4 \times 0.2 = 0.08 \leq 0.100 \times 0.8$ )

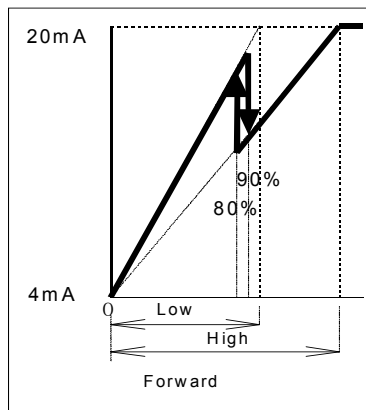

For Single Output, percentage "+\*\*%" is recognized as applicable to Forward Max. Flow Rate and percentage "-\*\*%" is recognized as flow rate zero.

For Double Output, percentage "+\*\*%" is recognized as applicable to Forward Max. Flow Rate and percentage "-\*\*%" is recognized as applicable to Backward Max. Flow Rate.

**Note :**

For "RATIO" input, the far left character on the display line is a plus or minus sign.

Display Menu No. : CHK-22: [FINISH] (ends Analog Output Check)

When Analog Output Check is active, mark <A > will appear at the far right of the 1<sup>st</sup> line , except when [STATUS 1] or [STATUS 2] is displayed.

After executing [FINISH], the <A > mark will disappear.

If power is shut off when Analog Output Check is active, this check mode will be concluded.

**c. Calibrating analog output (4-20mA current output)**

Display Menu No. : CHK-23 : [A-OUT CALIB]

Calibration is required for each output channel, CH1 & CH2.

Input check mark on “calibration” column.

Then calibration button for each channel shows up.

You can select CH and start analog loop calibration.

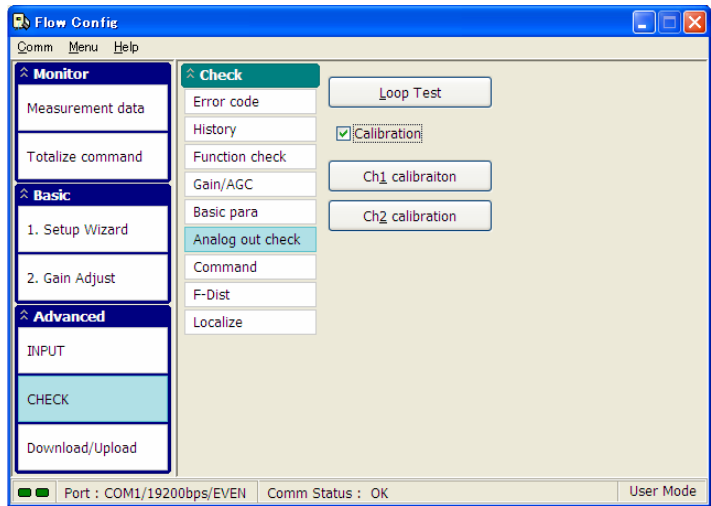

Flowmeter will output simulated value.

Please be noted that you must leave flowmeter from control loop.

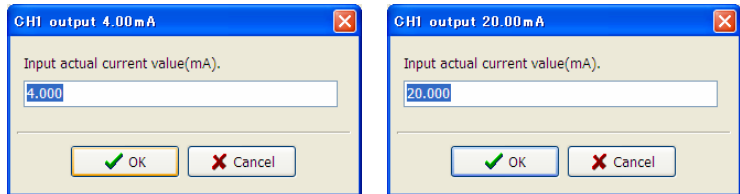

First 4mA will be output, please input measured value.

Then 20mA as above.

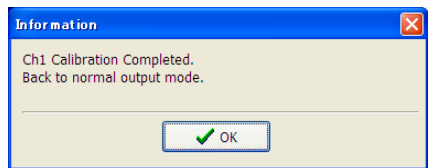

After calibration, please confirm to back normal mode as above.

NOTE; If you remove check mark on “calibration” column, you can check LOOP check.

Following 5 points will be checked.

4mA, 8mA, 12mA, 16mA and 20mA.

**d. Provisional measurement check in single range mode**

Display Menu No. : CHK-3 : RANGE

This function is used to set the output range (+/- Hi/Low).

When provisional range setting is activated, mark < R > appears at the far right of the 1<sup>st</sup> line, except when [STATUS 1] or [STATUS 2] is displayed. After executing [0: FINISH], the < R > mark disappears.

Note:

- If power to the flowmeter is shut down while this function is activated, this parameter will remain active when the system is rebooted.

**e. Checking single path measurement while multi-path measurement is activated**

Display Menu No. : CHK-4 : MULTI PATH

Select an active measurement path (1<sup>st</sup> path, 2<sup>nd</sup> path, 3<sup>rd</sup> path, or 4<sup>th</sup> path).

Mark < M > appears at the far right of the 1<sup>st</sup> line of the display when activating a measurement path except when [STATUS 1] or [STATUS 2] is displayed. The < M > mark disappears after [0: FINISH] is executed.

Note:

- If power to the flowmeter is shut down while this function is activated, this parameter will remain active when the system is rebooted.
- **While this function is activated, the SMOOTHING parameter, “INP-16: SMOOTHING” related to measuring path(s) is determined as follows.**  
[Input time (0 to 120sec)]/[Total number of measuring paths (1 to 4) input]

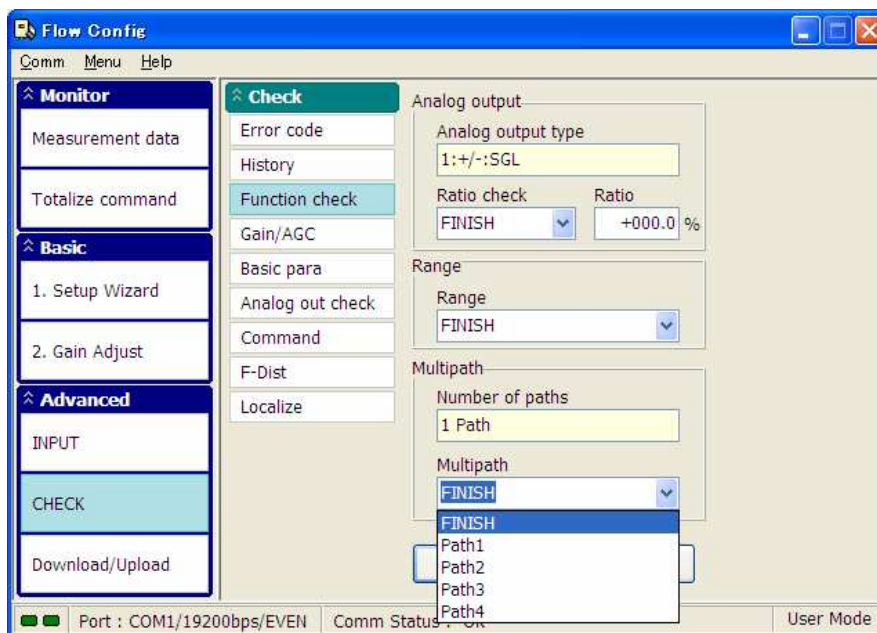

**f. AGA operation**

AGA (Automatic Gain Adjustment) function

The AGA function is performed after the transducers are attached and before measurement operation in order to set the optimum reception gain.

There are two modes - automatic and manual.

Display Menu No. : CHK-5: [GAIN]

MANUAL---#A (Gain to be set manually for all paths at once? Yes or No)  
                   #1 (1<sup>st</sup> path only)  
                   |  
                   #4 (4<sup>th</sup> path only)

AUTO-----#A (Gain to be set automatically for all paths at once? Yes or No)  
                   #1 (1<sup>st</sup> path only)  
                   |  
                   #4 (4<sup>th</sup> path only)

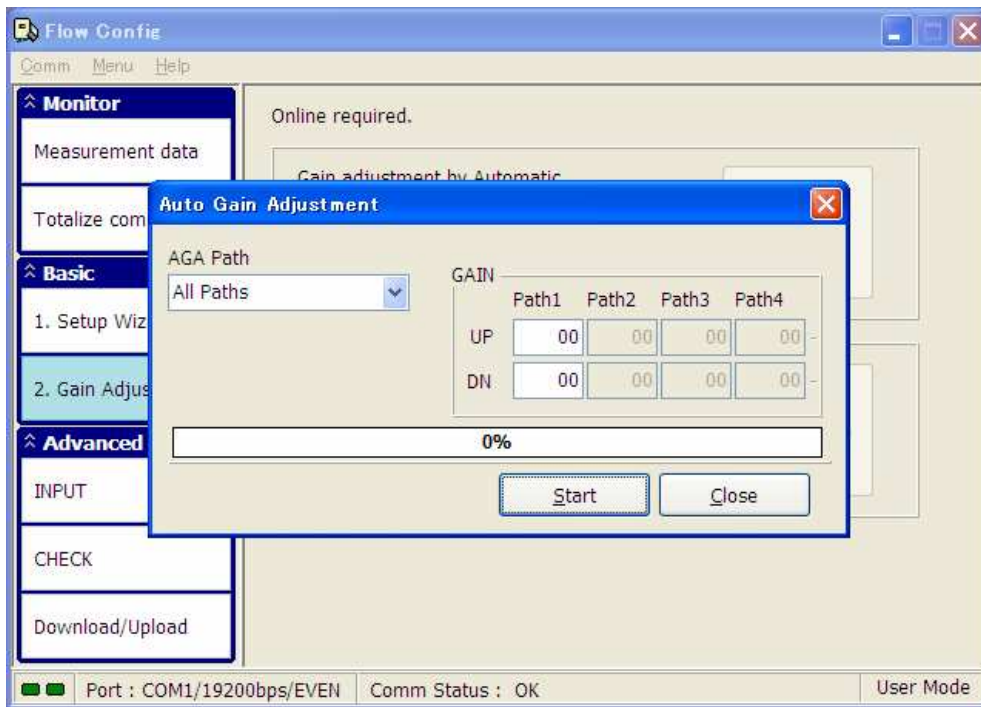

When you can not complete AGA settings in success and found error message as bleow, please refer to below and try again. Otherwise please contact our representatives.

aa) “bW” : Bubble Warning

The error will be indicated when pulse height fluctuates during AGA setting due to fluid conditions like air bubble contained.

In such case, you might be required flow condition change or change path method to shorter path. (ex. V method to Z method.) Then try again AGA function.

bb) “wW” : Wave distortion Warning

The error will be indicated when required ratio of pulse height for AGA setting can not be kept due to pipe conditions like inner corrosion.

In such case, you might be required mounting position change or change path method to shorter path. (ex. V method to Z method.) Then try again AGA function.

cc) "ROFF" : No receiving echo Warning

The error will be indicated when any echo cannot be detected on transducers.

- Mounting distance
- Mounting direction
- Cable connection
- Fluid condition
- Pipe condition
- Parameter settings
- .... and so on.

In such case, please check each cause and improve. Then try again AGA function.

In case of manual gain setting required, please refer to below.

However we recommend taking this procedure with oscilloscope for wave monitoring.

Open "Basic-Gain Adjust", and then click "Manual Gain".

Drag the slider bar then Write button or Click +/-1 button for gain change.

To up amplifier gain, please click + direction.

For reference, +12 gain means as doubled signal strength.

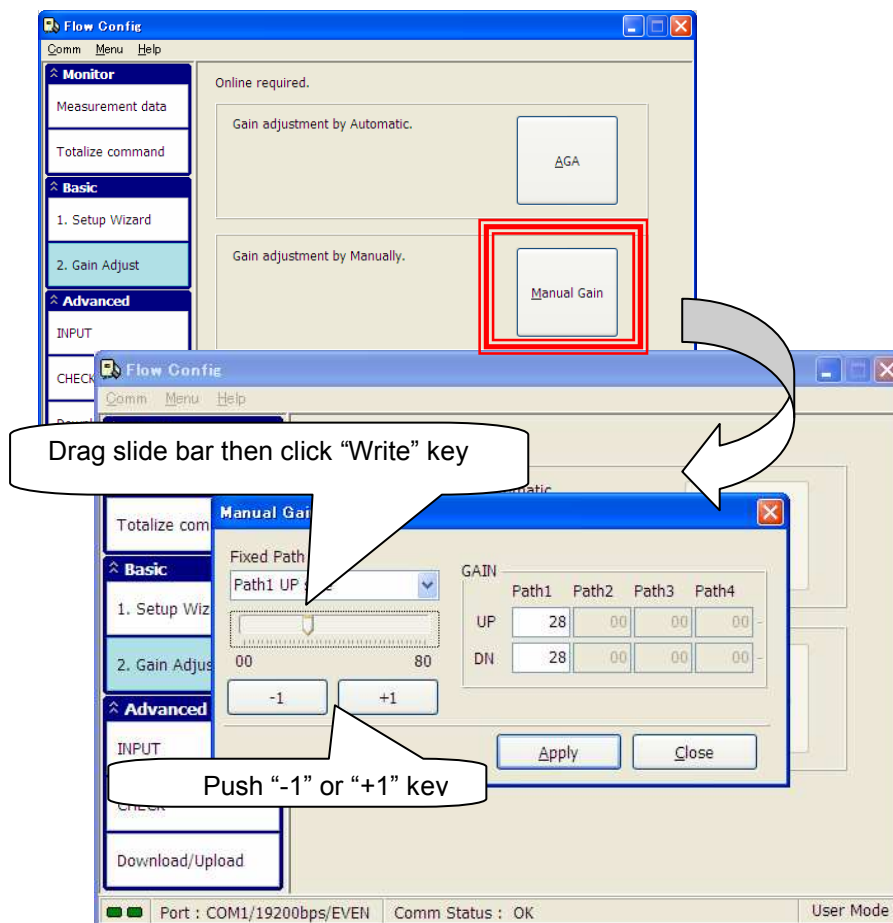

**g. AGC function**

The Automatic Gain Control function controls the gain automatically to maintain the reception echo at the level set with AGA when the reception echo becomes unstable.

Normally the Auto Gain Control is kept off, that is, [0: OFF] under CHK-6: AGC.

**Note:**

The AGC function must not be used in cases of turbulent flow as disturbances (air bubbles, cavitation, etc.) may hamper the flowmeter 's ability to regain proper measurement function. AGC should not be activated especially when there is a flow control valve located close upstream due to the possibility of cavitation occurring.

**h. Confirm sound velocity & Reynolds number**

Display Menu No. : CHK-7 : [BASIC DATA]

[Speed of sound] = Sound Velocity of liquid (Averaged)

[REYNOLDS] = Reynolds Number

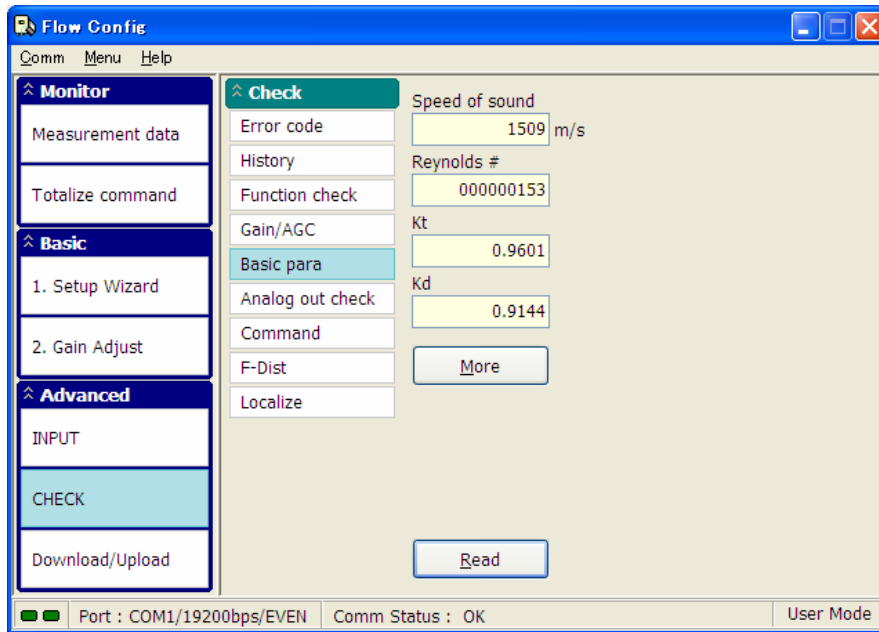



**i. Flowmeter self-diagnostics**

Display Menu No. : CHK-8 : [UF STATUS]

The flowmeter is equipped with a periodic self-check function.

Error Code	
ERR01-TX	Transmitting Circuit, OK or NG (w/ No. of path)
ERR02-RX	Receiving Circuit, OK or NG (w/ No. of path)
ERR-04-COUNTER	Time Measuring Circuit, OK or NG
	The result of time measuring
ERR08-ITG.MEMORY	RAM Check, OK or NG
ERR16-DATA MEMORY	ROM Check, OK or NG
ERR-32-PARAEMTER	Consistency Check of Input Data, OK or NG

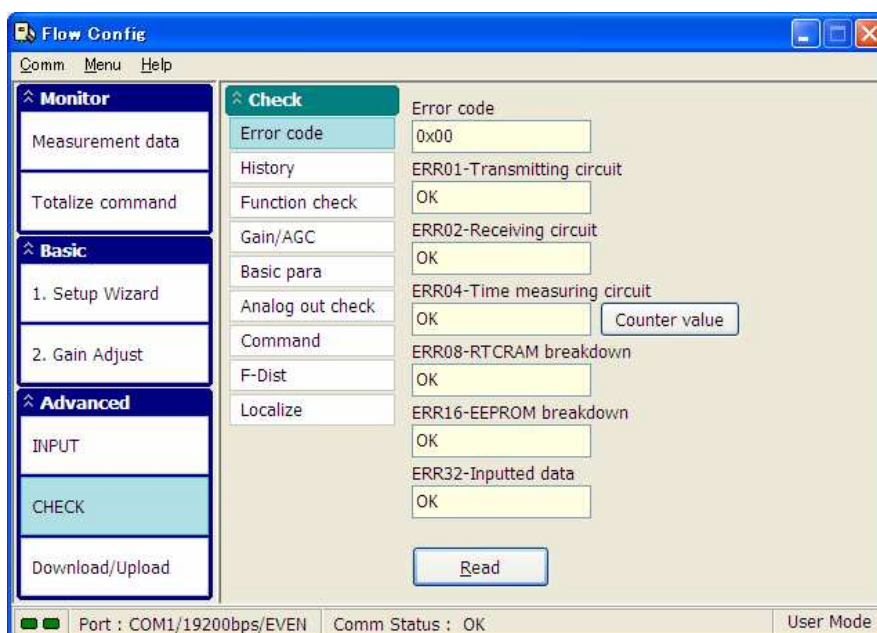

Note :

Regarding the detail of error codes, please refer to Table 4-1, 'Error Code List' under Chapter II-2-7.

## II-2-7 Output operating during aberrations in measurement

Fig. 4-4; Transition diagram during measurement aberrations

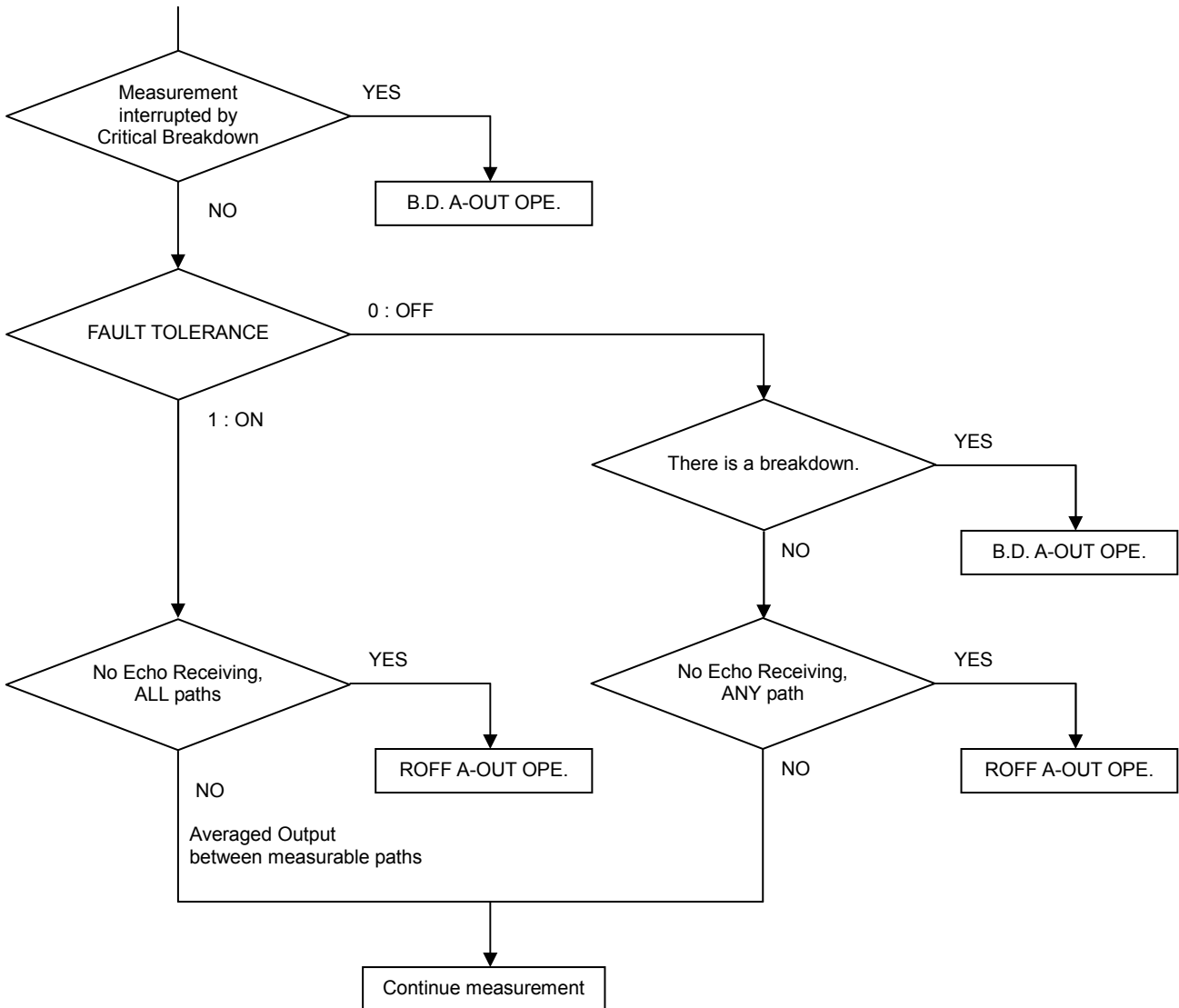

**Note:**

When setting “ROFF A-OUT OPE.” and “B.D. A-OUT OPE.”, the following operations can be selected.

0%	Output Zero flow
HOLD	Output the last value that was measured properly.
100%	Output maximum flow rate that was input
BURN OUT	Display Zero flow, Output current 20.8mA

- **Integration**  
Integration is continuous.
- **ROFF Contact Output & ROFF Alarm**  
ROFF contact output and alarm indication < R > is in accordance with the ROFF ALARM, INP-141.
- **B.D. Contact Output & Alarm**  
B.D. Contact Output is activated when there is a component failure and the display will indicate [ERR##]. A broken measuring path will be indicated as a no receiving echo [ROFF] condition.

• **Example of LCD Indication**

Normal

V	o	l	.		<	A	R	M	>	B	R	D	O	I
-	1	0	.	3	4	E	+	3		m	<sup>3</sup>	/	h	

When the flowmeter experiences a breakdown, an error code appears in the status area of the display.

V	o	l	.		E	R	R	1	6	B	R	D	O	I
-	1	0	.	3	4	E	+	3		m	<sup>3</sup>	/	h	

**Note:**

While “Check” function is activated, no error code is indicated.

**Table 4-1; Error Code List**

Breakdown Part	INPUT	EEPROM	RTC RAM	Counter	Receiving	Transmitting	Note
ID No.	32	16	8	4	2	1	B.D. = BreakDown
Error code							
ERR	1					1	Transmitting Circuit B.D.
ERR	2				2		Receiving Circuit B.D.
ERR	4			4			Time Measuring Circuit B.D.
ERR	8		8				RTC RAM B.D.
ERR	16	16					EEPROM B.D.
ERR	32	32					Inputted Data Error
Example of Composite Error Codes							
ERR	6			4	2		Time Meas. Circuit & Receiving Circuit B.D.
ERR	9		8			1	RTC RAM & Transmitting Circuit B.D.
ERR	20	16		4			EEPROM & Time Meas. Circuit B.D.

## II-2-8 Error Message

If invalid data or selection is entered, an error message will be displayed. The previous setting is automatically retained and the display will revert to the previous indication.

ex : When invalid data is input

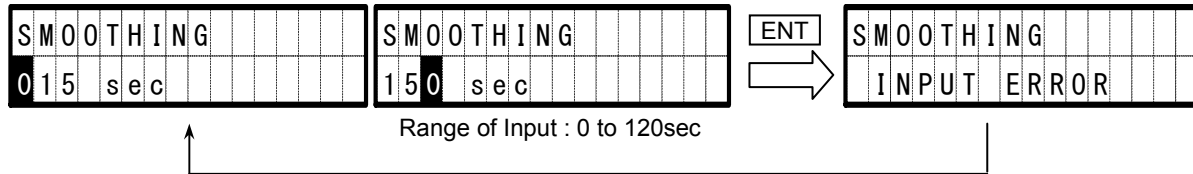

ex : When an invalid choice is selected

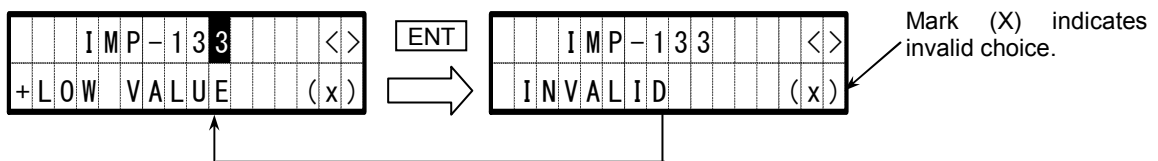

ex : When measured flow rate is over the maximum flow rate as set by + MAX VALUE parameter (INP-132 in A-OUT) or when converted velocity exceeds +/-30m/s.

Provided that +MAX VALUE (INP-132) was 100.00,

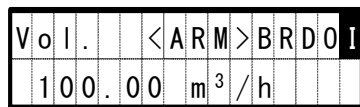

\* According to each setting

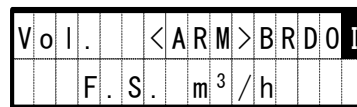

Over +MAX VALUE (more than 100.01)

LCD indicates 100.00 and F.S. alternately.

“F.S.” = Full Scale = Analog Output Range

ex : When values are over digits

Supposing that initial +MAX VALUE (INP-132) = 100 and initial -MAX VALUE (INP-134) = -100. If +MAX VALUE is changed to 0.300, according to the decimal places of +MAX VALUE, a -MAX VALUE of -100.000 should be indicated.

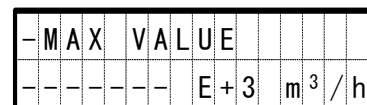

However the maximum no. of digits of the LCD for this string is 7, including decimal point and +/- sign. Thus -100.000, at 8 digits, will be deemed “Over Digits” and the -MAX VALUE display indication will appear as [ ----- ].



## **III. Other**

## Chapter III Index

### III-1. Maintenance and Inspections

III-1-1 Transducer and Main unit maintenance and Inspection .....	III-3
III-1-2 Lifetime of components .....	III-3

### III-2. General Specifications

III-2-1 Overall .....	III-5
III-2-2 Main unit .....	III-6
III-2-3 Transducer .....	III-13
III-2-4 Accessories .....	III-13
III-2-5 Dimensions .....	III-14
Main unit dimension .....	III-14
Transducer dimension (pipe dia. more than 300mm) .....	III-15
Mounting fixture for Transducer (pipe dia. more than 300mm) ....	III-15
Transducer dimension (pipe dia. less than 299mm).....	III-16
Mounting fixture for Transducer (pipe dia. less than 299mm).....	III-16
III-2-6 Analog output profiles.....	III-17
III-2-7 Digital output profiles (Original Protocol) .....	III-21
III-2-8 Digital output profiles (MODBUS Protocol) .....	III-30

### III-3. Principles of the ultrasonic flowmeter

III-3-1 Measurement Principles .....	III-37
III-3-2 Transmission and reflection methods .....	III-40

### III-4. Appendix

III-4-1 Flow volume and average flow velocity .....	III-41
III-4-2 Pipe conditions and required straight pipe length .....	III-42
III-4-3 Sound velocity & kinematics viscosity reference list .....	III-43

### III-5. FAQ

III-5-1. Measured method .....	III-45
III-5-2. Measured fluids .....	III-47
III-5-3. Pipes .....	III-48
III-5-4. Installation location.....	III-49
III-5-5. Other.....	III-52

### III-6. Troubleshooting

III-6-1. Main flowmeter unit and components.....	III-53
III-6-2. Measurement.....	III-54

### III-1. Maintenance and Inspections

Preventative maintenance and periodic inspection is important to ensure long life and proper functioning of the ultrasonic flowmeter.



#### Warning

When performing maintenance or inspections, shut down the main unit and stop the power supply to the equipment by an external disconnection device. If these measures are not taken, electrical shocks may occur.

#### III-1-1 Transducer and Main unit maintenance and inspection

Although maintenance of transducers or main unit is generally not required, be aware of the following items.

- (1) Inspect and clean the warning labels to ensure readability. Contact representative in your area of the manufacturer when warning labels have dirtied or peeled off.
- (2) Avoid subjecting transducers to shocks or impacts.  
Do not subject transducers to impact from hard objects, dropping, or other handle harshly in any other manner.
- (3) Do not tighten fastening sections.  
The transducer is fastened at the correct location using the attachment fixture. Therefore, further tightening may cause position deviation and make measurement impossible.
- (4) Although the transducers are designed with the possibility of water leakage in mind, long term exposure to water may speed deterioration in performance. Therefore, be sure to quickly drain water after leakage occurs.
- (5) Even when a transducer deteriorates, since there is no change in external appearance, except for extreme cases, the maker based on the inspection contract (separate specification) may do an inspection. Performance deterioration is evaluated by observing received ultrasonic waves and comparing the results with the waves received during normal operation.
- (6) If the equipment is dirty, clean it with a soft cloth. Do not use the medicine when cleaning.

#### III-1-2 Lifetime of components

Certain components of the main unit have operational life expectancies. Periodic check of these components is recommended. Please contact the Tokimec representative in your area of the manufacturer when any component replacement is required.

##### (1) LCD

The specified electrical life of the LCD which is part of the main electronics unit is 5 years under room temperature. The contrast of the LCD may darken when this life is exceeded although the operational and measurement functions of the unit are not affected. (Contrast is adjustable. Please refer to Chapter II-2-3 "LCD Indication and Operation".) Generally LCD life may be shortened if it is exposed to direct sunlight or high temperature.

##### (2) Lithium battery (for totalizing backup)

The lithium battery which is used for totalizing value backup requires replacement approximately every 5 years even if the main electronics units is kept on the shelf under storage.

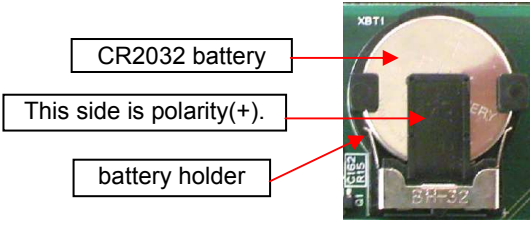

Under normal operation of the flowmeter, battery power is consumed through self-discharge. (Memory does not consume battery power.) Under such usage, the battery should normally be replaced approximately every 10 years. Also pay attention to the "B" mark (low battery warning) indicator appearing on the LCD display.

<p><b>⚠ WARNING</b></p> <ol style="list-style-type: none"> <li>1. Use only specified battery.</li> <li>2. Do not short-circuit positive(+) and negative(-) terminals of the batteries (for example, by connecting them with metal).</li> <li>3. Do not recharge the batteries.</li> <li>4. Insert the batteries with polarity (+)(-) correctly.</li> <li>5. Dispose of used batteries promptly. When the battery is disposed, isolate positive(+) and negative(-) terminals of the battery to avoid those terminals touch each other.</li> </ol>	
<p><b>⚠ CAUTION</b></p> <p>Do not drop, apply excessive damage or deform the battery.</p>	
<p>Battery specification</p>	<p>Battery setting polarity</p>
<p>Coin type Lithium battery Model CR2032 Rating 3V, 220mAh</p>	

(3) Fuse

The fuse should normally be replaced approximately every 10 years. When fuses are blown, check for ground fault, short-circuits, insulation defects, and abnormalities in the power source. When no problems are detected, replace the blown fuses. When all problems cannot be ruled out, or when replaced fuses continue to blow out, contact the maker.

<p><b>⚠ WARNING</b></p> <p>Use only specified fuse. Refer to "Fuse" in clause III-2-2 "Main Unit" for specification.</p>
--

(4) Power supply board

The design life of the power supply board is 10 years at an ambient temperature of 40°C. The life of this component is determined by the life of the capacitor. Generally, a temperature 10°C higher than this ambient temperature will shorten the life by half and conversely a temperature 10°C below this established ambient would double its life.

(5) Packing, cable entry, O-rings

EPDM (ethylene-propylene rubber) is used for,

- seal packing of the main electronics unit cover
- seal packing for skin-top and main electronics unit

CR (chloroprene rubber) is used for,

- inner packing of cable glands

Periodic checks for packing deterioration is recommended to insure IP class performance.

## III-2. General Specifications

### III-2-1. Overall

Measurement	Fluids	Homogeneous and sonically conductive fluids (water, waste water, industrial water, river water, sea water, pure water, etc.)
	Temperature range	-20°C to +115°C (depend on transducer)  Note: 1) above also applicable to ambient temperature 2) For main unit, -10°C to +60°C
	Turbidity	10000 mg/L or less
Pipes	Material	Materials which allow stable transit of ultrasonic waves such as steel, SUS, castings, ductile casting, PVC, FRPM, etc.  Note: Applicable diameters may vary with material.)
	Diameters	DN25mm to DN6000mm
	Lining	None, tar epoxy, mortar, etc.
Measurement Range	Converted to flow velocity: -30 m/s to +30 m/s	
Measurement Cycle	60 ms	
Measurement Accuracy	D ≥ 300mm, ±1% of reading, however ±0.008m/s for velocities less than 0.8m/s. D < 300mm, ±1% of reading, however ±0.02m/s for velocities less than 2m/s.  Note: 1) For volumetric flow rate. 2) Fully developed and rotationally symmetrical flow profile required.	
Repeatability	±0.5%	
Range ability	1 : 300	
Measurement Method	Ultrasonic pulse transit time difference method	

European Compliance (CE marking)	<p>EMC Directive 2004/108/EC          Harmonized Standard / EN61326-1:2006          Separation into group / Group I          Division into classes / Class A          Location intended for use / In industrial locations</p> <p>Low Voltage Directive 2006/95/EC          Harmonized Standard / EN61010-1:2001          Over voltage category II          Pollution degree II          Altitude up to 3000m</p>
----------------------------------	--

### III-2-2. Main Unit

#### [Main Unit]

Analog output	St'd/option	Standard
	Output	<p>Instantaneous flow rate</p> <p>Number of outputs: 2</p> <p>Output pattern: 1 system parallel output, 8 types 2 system output, 10 types Special output, 1 type</p> <p>Note:</p> <p>1) Instantaneous flow rate will change to velocity value in case of velocity mode.</p> <p>2) Ch2 output will be the same type as ch1 output when 1 system or special output is selected. (parallel output)</p>
	Output format	<p>4 - 20mA (1 system / 2 system output)</p> <p>0.8 - 20mA (special output)</p> <p>20.8mA (Burnout when no echo received or during failure warning (span +5%) output possible)</p> <p>Max. allowable load resistance 1 K ohm, insulated outputs</p>
	Terminal panel	Screw less Terminal (0.08~2.5mm <sup>2</sup> cable applicable)

Contact point output	St'd/option	Standard
	Output	<p>For each of the 4 contact points, output selection allocation as follows. (parallel output possible)</p> <ol style="list-style-type: none"> <li>1. Forward flow totalized pulse</li> <li>2. Backward flow totalized pulse</li> <li>3. No echo received warning</li> <li>4. Equipment failure warning</li> <li>5. Equipment failure or no echo received warning</li> <li>6. Upper limit warning</li> <li>7. Lower limit warning</li> <li>8. Forward flow detection</li> <li>9. Backward flow detection</li> <li>10. High range detection</li> <li>11. Low range detection</li> <li>12. Not used</li> </ol> <p>Note:</p> <p>1) Pulse width of contact is selectable from 1000,500,100 or 20ms. But not for both forward and backward.</p> <p>2) Each default setting is "ON" at work, but "OFF at work is also selectable.</p>
	Output format	Photo coupler (insulated)
	Contact point capacity	DC48V, 0.4A
	Notes	<p>Totalize units</p> <p>0.01L, 0.1L, 1L, 10L, 100L, 1m<sup>3</sup>, 5m<sup>3</sup>, 10m<sup>3</sup>, 100m<sup>3</sup>, 1000m<sup>3</sup>, 10000m<sup>3</sup> 1g, 10g, 100g, 1kg, 10kg, 100kg, 1t, 10t, 100t, 1kt, 10kt, 100kt ft<sup>3</sup>,kft<sup>3</sup>,Mft<sup>3</sup>, bbl, kbbl, Mbbl, gal, kgal, Mgal, acf, kacf, Macf</p> <p>Valid units may be limited depending upon the selected flow unit.</p>
	Terminal panel	Screw less Terminal (0.08~2.5mm <sup>2</sup> cable applicable)

Digital output	St'd/option	Standard
	Output 1	<p><b>One-way output mode</b></p> <p>Following data is output per set output cycle Instantaneous flow rate, forward/backward flow totalized value and various warnings. (flow meter mode: linear flow rate and various warnings)</p> <p>Note: Instantaneous flow rate will change to velocity value in case of velocity mode. No totalized values available.</p>
	Output 2	<p><b>Intercommunication mode</b></p> <p>Connection to PC enables setting of flowmeter unit, setting menu and reading of measurement values and operation status.</p>
	Output type	RS232C (non-insulated output)
	Output cycle	1 to 3600 seconds possible. (output 1 only)
	Communication speed	4800 bps, 9600 bps or 19200 bps selectable
	Data bit length	8 bit/1 stop bit
	Parity check	EVEN
	Format	Original Format (ASCII) MODBUS (Selectable; only for Output1)
	Synchronization	Asynchronous
	Cable length	Up to 3m
		Note: To comply with EC directives, use less than 3m cable.

Multi-path measurement	St'd/option	Option
	Quantity	2 path or 4 path
	Details	<p>2 path:</p> <ul style="list-style-type: none"> <li>- 1 additional pulser module required and installed in main unit (total 2 modules).</li> <li>- Transducer, fixture, extension cable for each path required.</li> </ul> <p>4 path:</p> <ul style="list-style-type: none"> <li>- External multi-path junction box is required and 2 special coaxial composite cables are connected to the flowmeter main unit.</li> <li>- Transducer cable connected in junction box by BNC connector.</li> <li>- 3 additional pulser modules required and installed in main unit. (total 4 modules).</li> <li>- Transducer, fixture, extension cable for each path required.</li> </ul>

Data setting	Setting method	PC connected to Digital Output port 2, setting through PC with configuration software (LCD 4-keys entry is available, but limited).
	Setting items	Indication, Unit (Flow rate and Totalizing) Flow Range and various settings

Measurement display	Display method	LCD (16 character x 2 lines), with backlight Over 5 years life (by 25°C)	
	Display content	Switchable display of following: <ul style="list-style-type: none"> <li>• Instantaneous flow rate, warnings, check mode and totalizing status.</li> <li>• Instantaneous flow velocity value, warnings check mode and totalizing status.</li> <li>• Forward flow totalized value, warnings, check mode and totalizing status.</li> <li>• Backward flow totalized value, warnings, check mode and totalized status.</li> <li>• Status1 (AGC, Range, Warnings and Check mode)</li> <li>• Status2 (Number of R-OFF warning &amp; Disturbance Elimination function worked.)</li> </ul> Note: <ol style="list-style-type: none"> <li>1) During power failure, displayed screen component is memorized and displayed when power is again introduced.</li> <li>2) Instantaneous flow velocity of each path can be indicated on display in case of multi-path installation.</li> <li>3) Counter can be reset by key pad operation.</li> </ol>	
	Display digits	Instantaneous flow rate:	Dependent on max. flow rate for Analog output setting. Max. 7 digits including sign, decimal point. Forward Max. 7 digits Including Decimal point Range: 0 to 99999.0 Backward Max. 7 digits including Sign and Decimal point Range: -0 to -99999
	Instantaneous flow velocity:	sign section 1 digit integer section 2 digits decimal fraction 3 digits fixed	
	Totalized flow:	7 digits	
	During exceeding Max. range of flow rate for Analog output setting, indication would be "Instantaneous flow rate" and alternated flickering with "FS" (Full Scale) mark.		

Measurement display	Display content	
(cont.)	Warnings	<p>Backup battery remaining life</p> <ul style="list-style-type: none"> <li>- "B" displayed when battery voltage falls below prescribed value.</li> <li>Not detectable when battery would not be equipped itself.</li> </ul> <hr/> <p>No Echo received warning</p> <ul style="list-style-type: none"> <li>- "R" displayed during processing when no wave received.</li> </ul> <hr/> <p>Disturbance Detection</p> <ul style="list-style-type: none"> <li>- "D" displayed when the measuring condition disturbed by air bubbles, solids or other factors.</li> </ul> <hr/> <p>Over Range</p> <ul style="list-style-type: none"> <li>- "O" displayed when the measuring value exceeds upper or lower limitation setting.</li> </ul>
	Check	<p>"&lt;A--&gt;", "&lt;-R-&gt;", "&lt;--M&gt;" displayed during various check operations.  (A: 4-20 check; R: range check; M: multi-path check)  "&lt;ARM&gt;" appears during combined display.</p>
	Totalizing Status	<p>"I" displayed blinking when totalizing function operated.</p>
	Failure warning	<p>"ERR01" to "ERR63" displayed during equipment failure.  Check operation display is replaced by this failure display.</p>
	Status 1	<p>"AGC" displayed in case of AGC function on.</p> <hr/> <p>"LO-RNG" displayed in case of low range output.</p> <hr/> <p>"HI-RNG" displayed in case of high range output.</p>
	Status 2	<p>Number of "R-OFF warning" function worked.</p> <hr/> <p>Number of "Disturbance Elimination" function worked.</p>

Function	Low flow cut	Cuts (zeros) flows when flow falls below prescribed instantaneous flow rate. Used in order to avoid output of flow values other than 0 when measurement value during still flow becomes disordered.
	No Echo receiving warning	<p>If measurement cannot be made when no echo is received continuously over the setting time (determined transition time), status is changed to</p> <ul style="list-style-type: none"> <li>- Selected analog output type     Selectable analog output transition status as follows.     0% (4mA), hold, 100% (20mA), burnout (20.8mA)</li> <li>- Display "R" on LCD.</li> <li>- Contact output of warning if set.</li> </ul> <p>Note:</p> <ol style="list-style-type: none"> <li>1) Measurement values and analog output will be restored when echo is received continuously over the setting time (determined restore time).</li> <li>2) In case of multi-paths, processing can be selected to change output for no echo receiving for 1 path or for all paths.     Initial setting value is for no echo receiving for all paths.</li> <li>3) If measurement can be made for even 1 path, measurement will be continued for only this path.</li> </ol>
	Disturbance detection	<p>Check whether processing values are measured properly or not and if determined to be disturbed conditions then measuring values are eliminated.</p> <ul style="list-style-type: none"> <li>- Display "D" on the display</li> <li>- Count up as history on status 2</li> </ul>
	Zero Shift compensation	Zero point can be independently compensated (shifted) for forward and backward flow rate.
	Span compensation	Slope of span line can be independently compensated for forward and backward flow rate in the range 0.100 to 2.000.
	Filtering (Smoothing)	<p>Rapid flow rate changes would be smoother by this filter for 1 to 120 sec. (Default 15sec)</p> <p>Note: This value is meaning the time until measuring flow rate reaches 90% by step-up increment.</p>
	Self-diagnostics and failure processing	<p>Self-diagnostics is run periodically.</p> <p>If failure is diagnosed on following items, transitions to be selected status.</p> <p>Diagnostic checks:</p> <ol style="list-style-type: none"> <li>1) Memory Area check (for totalizing and setting parameter)</li> <li>2) Parameter check</li> <li>3) Time measurement counter malfunction</li> <li>4) Transmitter malfunction</li> <li>5) Receiver malfunction</li> </ol> <ul style="list-style-type: none"> <li>- Selected analog output transition status as follows.     0% (4mA), hold, 100% (20mA), burnout (20.8mA)</li> <li>- Display "ERR**" on LCD. (** is error number.)</li> <li>- Contact output of warning if set.</li> </ul> <p>Note: "AND" , "OR" condition is selectable in accordance with fault tolerance function setting.</p>

Function (cont.)	Data retention	<p>Totalized flow values and all setting parameters are retained in memory with lithium battery even if power failure.</p> <p>Note:</p> <ol style="list-style-type: none"> <li>1) Setting Parameters are retained in nonvolatile memory.</li> <li>2) Totalized flow value and ROFF/Disturbance detection history are retained in memory which hold by Back-up Battery.</li> <li>3) Data retained in memory which hold by Back-up Battery clears if battery removed without power supply.</li> <li>4) 5 year life at room temperature.</li> <li>5) No battery recharging function.</li> </ol>
	Analog output check	Output can be freely changed depending on analog output setting. Setting every 0.1% of flow span range (-120.0 to + 120.0) possible.
	Path fixing	Measurement of specified path can be fixed and flow checked for every path when using multi-paths.
	Automatic Gain adjustment (AGA Function)	Receiver gain can be set as ideal amplitude by automatically or manually. (Manual gain setting is done conventionally by monitoring receiving echo with oscilloscope)
	Analog output range switching	Analog output range is automatically switchable when double range mode.
	Automatic gain control (AGC Function)	Receiver gain is automatically adjusted to the optimum level in response to changes in receiver sensitivity during measurement.  Note: Not available in case of containing air bubble or nearby flow control valve.
	Forward / Backward flow change processing	Hysteresis can be set by time in order to avoid flapping of direction detection contact points when there are back and forth, plus and minus changes in measurement values during still water condition.
	Totalized value preset	Totalized values can be freely preset. Preset Range: 0 to 9999999
	Basic data display	Following internal data can be referenced. - Fluid sonic velocity (unit, m/s) - Reynolds Number - Amp. Gain
Error historic counter	Count "No Echo receiving warning" & "Disturbance detection" when it occurred.	



Power supply	AC100 to 230V +/-10% (50/60 Hz±10%) Option : DC24V±20% (This option must be pre-selected)	
	Momentary outage	AC input: 20ms, DC input: 5ms
Power consumption	AC100V: 20VA / AC200V: 27VA DC24V: 10W (Option)	
Fuse	IEC 60127-2 SS5 Cartridge fuse-links φ5.2x20 mm Rating 2A/250V Time-lag High Breaking Capacity (1500A)	
Rush Current	Less than 20A at AC100V / Less than 32A at AC200V Less than 30A at DC24V (Option)	
Operating temperature range	-10 to +60°C (for main unit ambient)	
Storage temperature range	-20 to +70°C	
Operating humidity range	Less than 90% RH, non-condensation	
Main unit construction	Protection Degree IP65 (IEC 60529)	
Wiring connection port	Cable gland, 7 pcs, O.D.6~12mm cable applicable	
Case material	Aluminum	
Coating	Melamine	
Color	Munsel 10YR9. 4/0. 5	
Weight	Appx. 8kg	
Dimensions	260mm x 394mm x 155mm	

### III-2-3 Transducers

Transducers	Large diameter	SE044040NC	(-20°C to + 65°C)
	Large diameter narrow space	SE042140NC	(-20°C to + 65°C)
	Large diameter high temperature	SE044040N-HT	(+60°C to +115°C)
	Small diameter	SE104720	(-20°C to + 60°C)
	Small diameter high temperature	SE104020N-HT	(+60°C to +115°C)
Note	Water proof performance	Protection Degree IP67 (IEC 60529)	
	Construction	one piece construction with 5m cable	
	Cable	coaxial cable with double shielded insulation between sheaths	
	Cable max. length	300m	

### III-2-4 Accessories

Cable Junction box	St'd/option	Option
	Construction	IEC 60529 Protection Degree IPX4
	Material	Aluminum casting
	Connection port	4 locations (2 locations each side)
Multi-Path Junction box	St'd/option	Option
	Construction	IEC 60529 Protection Degree IP66
	Material	Aluminum casting
	Connection port	10 locations (2 for Main Unit side & 8 for Transducers side)
	Cables	Included 1m Special Composite Coaxial Cable with Connector to Main unit.
Power Cable (*1)	St'd/option	Prepared by User
	Model name	OLFLEX Classic 100
		multi-conductor, flexible power and control cable
	Part Number	10060
	Manufacturer	LAPP KABEL
Details	3 Conductors AWG16, 1.5 mm <sup>2</sup> Nominal Outer diameter 8.1 mm	

(\*1) Power cable is specified to comply with EC directive.

Main Unit

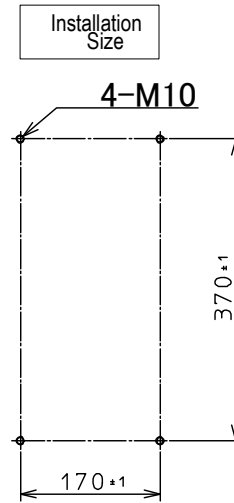
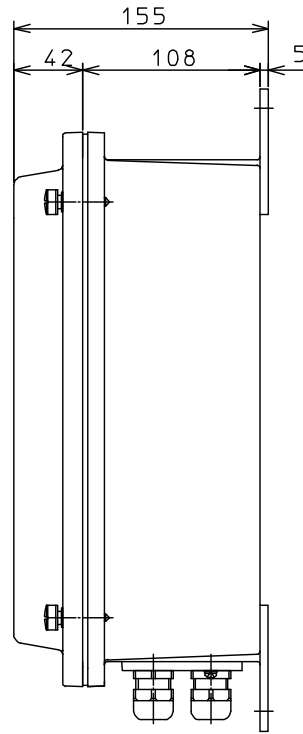
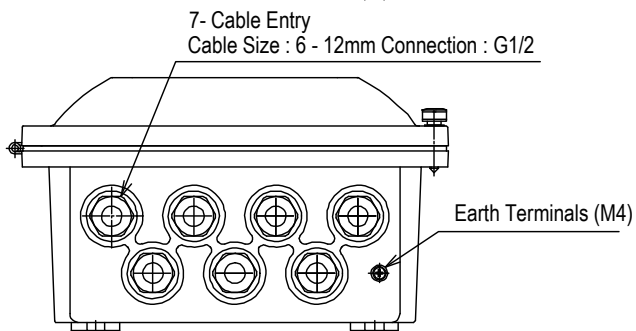
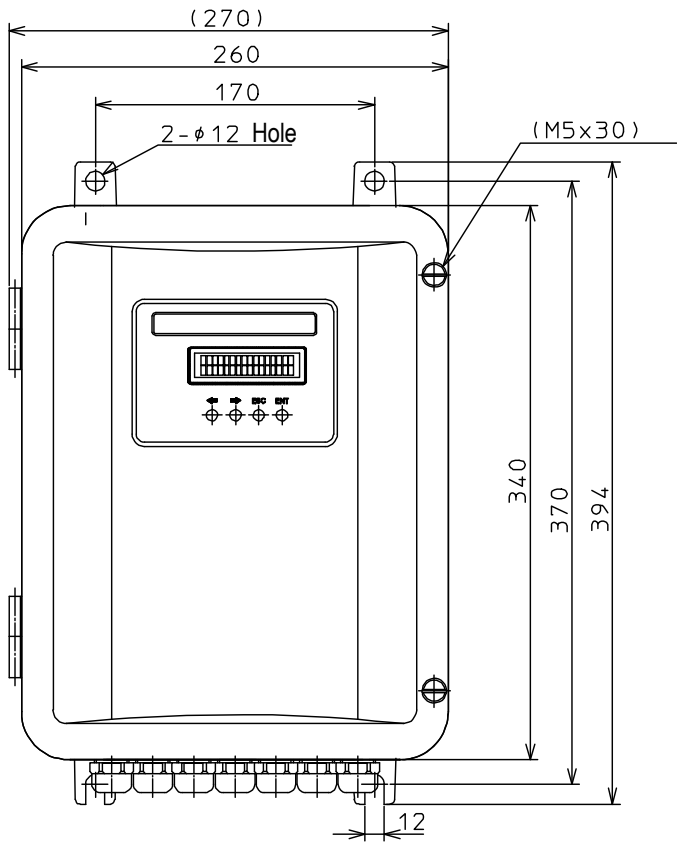

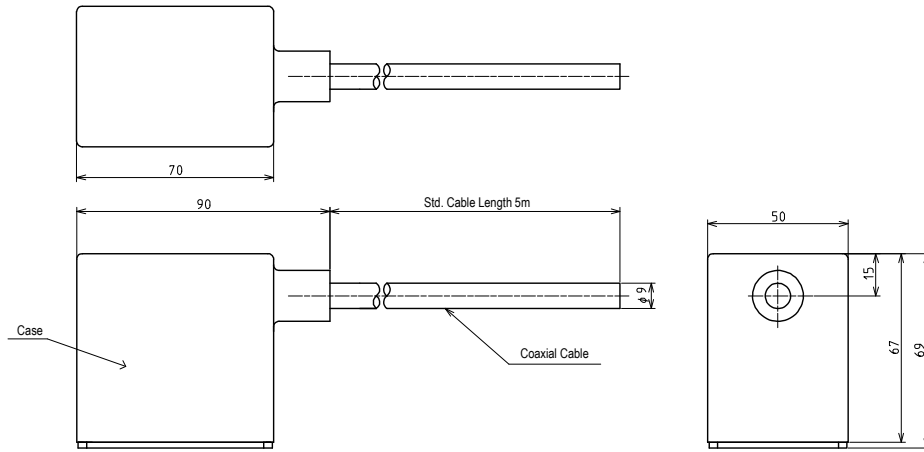

Transducer Dimensions (Pipe Dia more than 300mm)

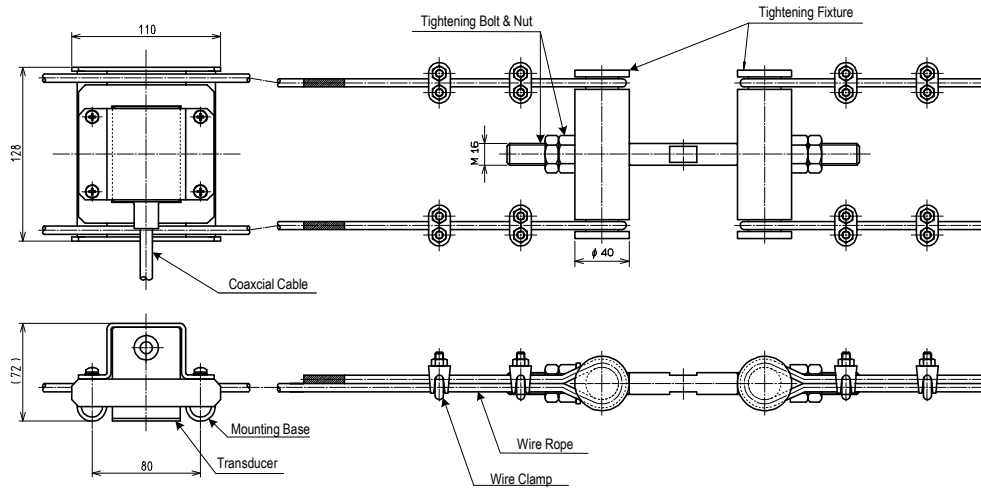

Mounting Fixture for Transducers

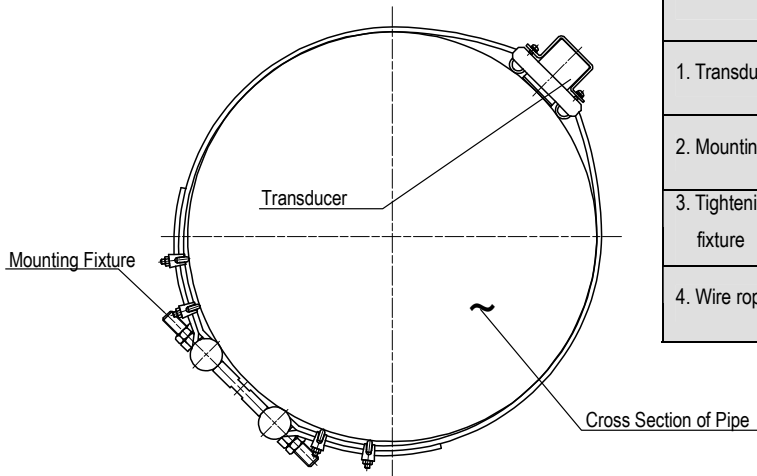

Mounting Example

Components	Q'ty for 1path	Material	Weight (appx.)
1. Transducer	2pcs	SCS13	2.0kg per 2pcs
2. Mounting bracket	2pcs	SUS304	1.9kg per 2pcs
3. Tightening fixture	Less than 1600mm	SUS304	5.2kg per 2pcs
	More than 1600mm		
4. Wire rope	Less than 1600mm	Stainless	180g per 1m
	More than 1600mm		

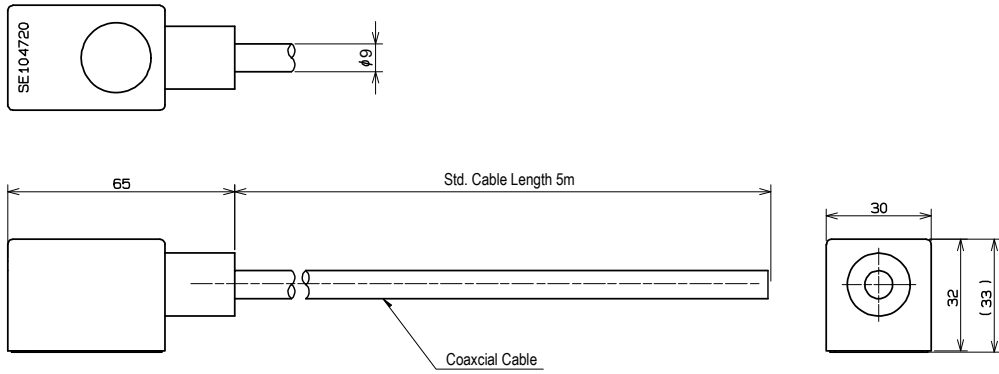

Transducer Dimensions (Pipe Dia less than 299mm)

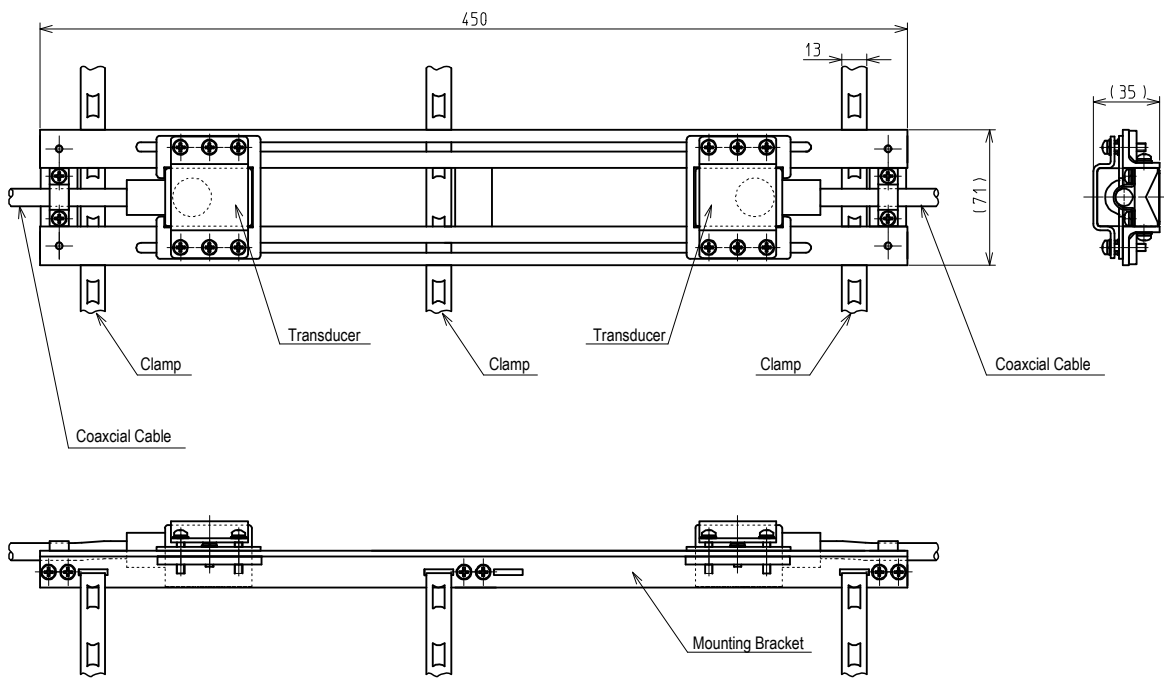

Mounting Fixture for Transducers

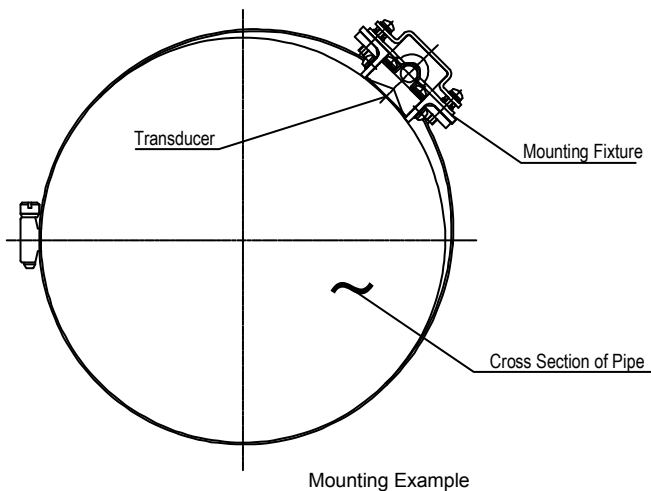

Mounting Example

Components		Q'ty for 1path	Material	Weight (appx.)
1. Transducer		2pcs	SCS13	1.4kg per 2pcs
2. Mounting bracket		1pc	SUS304	2.9kg per 1pc
3. Clamp (SUS belt)	125mm-250mm	3pcs	SUS304 t:0.6mm	35g per 1pc
	25mm -100mm	2pcs		

### III-2-6 Analog output profiles

Table1: Analog Output Profile Table

#### (1) Single System Output 1/2

Profile Description		CH1,CH2 Common Output
One-Way Single Range		
Two-Way Single Range		
One-Way Double Range	Automatic Double Range	

#### (2) Single System Output 2/2

Profile Description		CH1,CH2 Common Output
Two-Way Double Range	Automatic Double Range	
Special		

Table 1 (continued)

(3) Dual System Output 1/2

Profile Description		CH1 Output	CH2 Output
Two-Way Single Range			
One-Way Double Range Internal Switching	Automatic Double Range		

(4) Dual System 2/2

Profile Description		CH1 Output	CH2 Output
Two-Way Double Range Internal Switching	Automatic Double Range FW/BW		
	Automatic Double Range HI/LO		







### III-2-7 Digital output profiles (Original Protocol)

#### (1) Overview

Flowmeter can provide digital data output of flowrate, velocity data, totalizing value as well as measurement status.

This digital data is output from DIGITAL port1 in CSV format (text data separated by commas) via EIA-232 (RS-232C) connection by Original protocol.

#### (2) Connection

Main unit and PC must be connected in accordance with the following steps.

- Connect cable to digital port1 (left side of 2 ports) of the main unit.
- Connect cable to the serial port of the PC through the converter (adapter).

 <b>CAUTION</b>
<ol style="list-style-type: none"> <li>Connection cable length must be less than 3 m long to comply with EC directive.</li> <li>Do not connect the connection cable to LAN connector of the personal computer, that may damage the flowmeter main unit and/or the personal computer.</li> <li>Make sure that connections are made correctly as incorrect connections may result in damage to the main unit and connected accessories.</li> </ol>

If you desire to maintain the IP class with digital communication, please consult manufacturer or representatives. The IP class cannot be maintained with standard LAN cables (straight type) with standard skin-top connector.

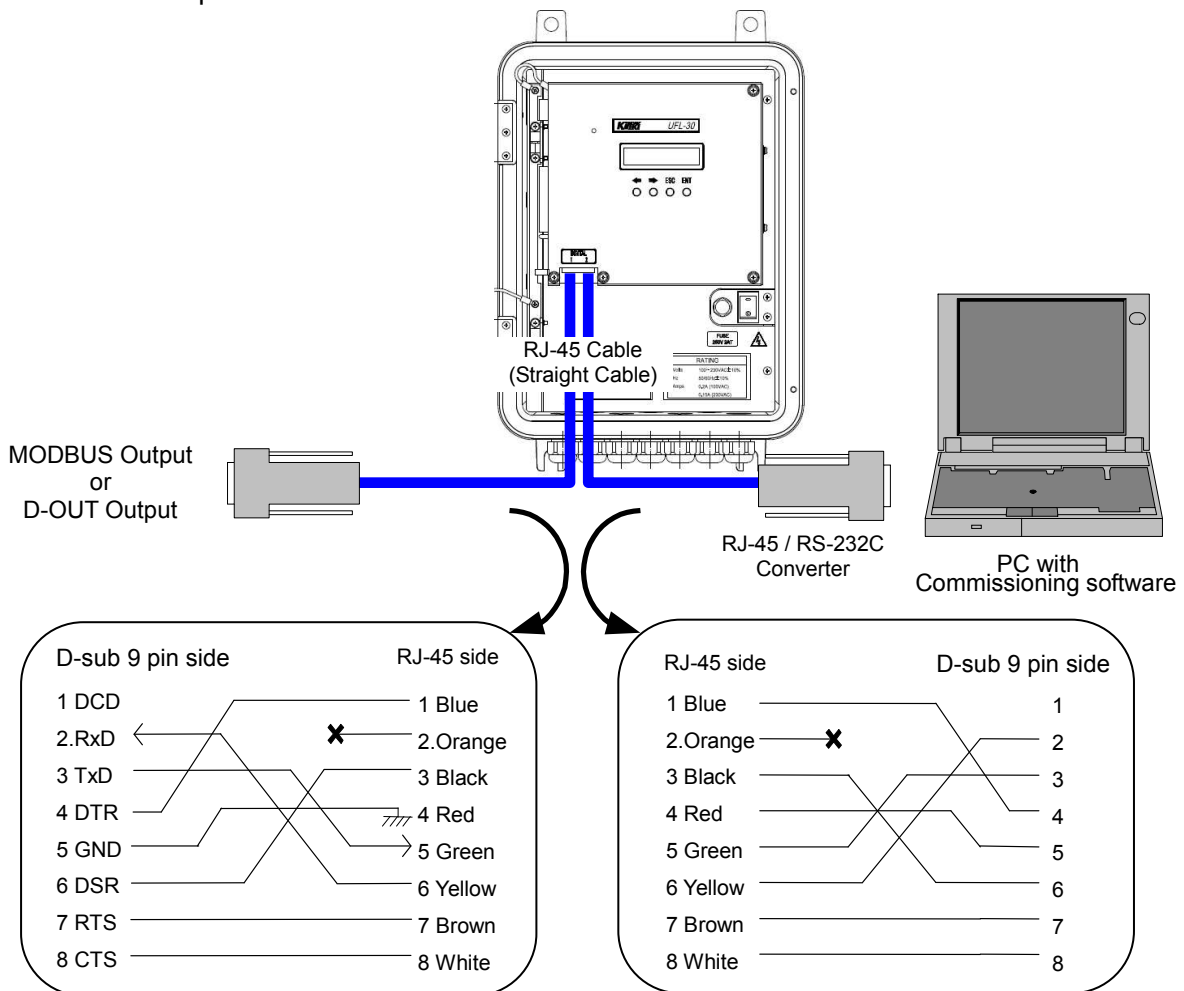

NOTE; Each “RTS and CTS”, “DTR and DTS” of Digital Port 1 is shorted on flowmeter ‘s main unit side.

### (3) Data receiving with Hyper-Terminal of Windows

Standard windows bundled software Hyper-Terminal handles digital data from main unit. Please refer to the following procedures.

**(Note: The following instruction example is based on a Windows XP version display.)**

#### 3.1. Activate Hyper-terminal

#### 3.2. Enter "Connection Name"

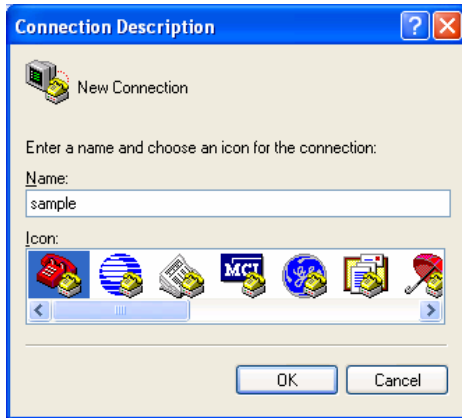

#### Instruction

You can use any name as the connection setting name. Enter the name, then click OK. (In this example, the name entered is "sample".)

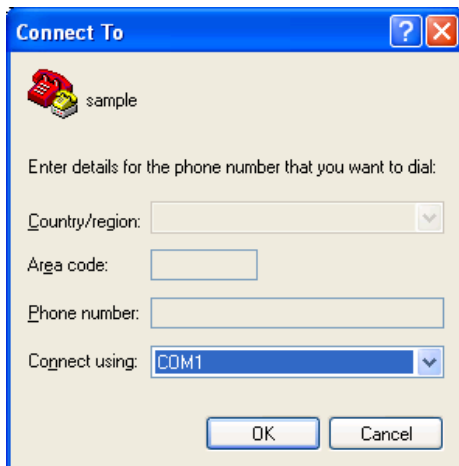

#### Instruction

Select & set communication port.

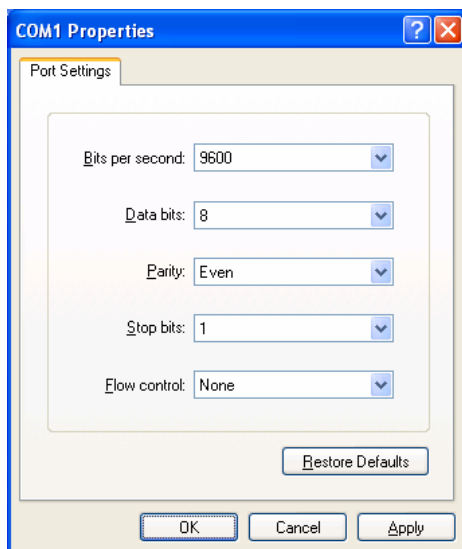

#### Instruction

Set port settings as below.

Bit/sec	9600 <sup>Note1</sup>
Data bid	8
Parity	even
Stop bit	1
Flow control	none

#### Note 1

"Bit/sec" must match the main unit settings.

### 3.3 Confirm receiving data

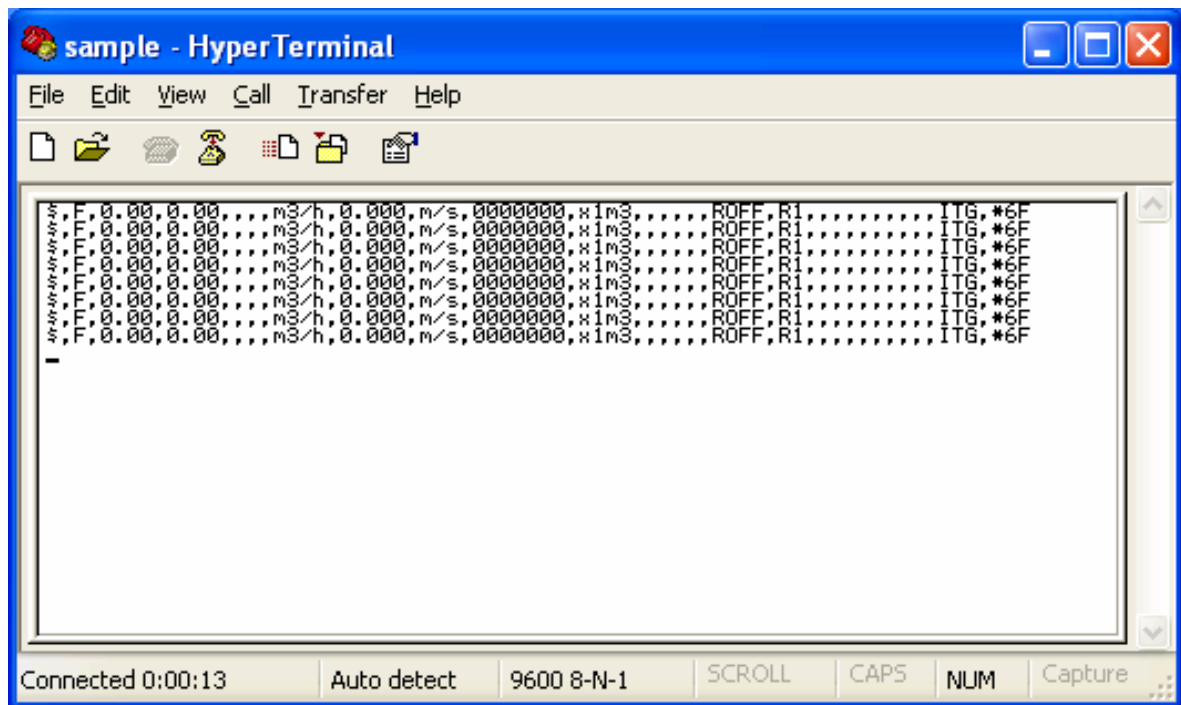

#### Instruction

Display of receiving data is shown at left.

Instructions for detail data format are provided in Chap. 4.

#### (4) Data Format

Detail format output from DIGITAL port 1 is as follows,

[Sample Data]

\$,F,0.000,0.000,,,E+3:m3/h,0.000,m/s,0000000,x1m3,,,,,ROFF,R1,,,,,OVER,,,,,ITG,\*06[CR][LF]

Data output from UFL-20A are referred to as a line of data interchange. Data items in each line are contained in data FIELDS which are numbered, for example "field 0", "field 1" and so on until it ends at "field 28". Each data FIELD contains a single data VARIABLE. The order of data FIELDS on each line is defined by a data HEADING "\$", with the rest of the data line written in [CR][LF] code. The data field HEADINGS and data VARIABLES on each line are separated by commas.

Empty data FIELDS are enclosed by double quotes, " , , , , " .

The applicable FIELDS of data are as follows,

Table 4.1 Field Data

Field No.	Data Description	Sample
0	<i>Header</i> This character indicates the start of the line.	<u>\$</u>
1	<i>Operation mode</i> F ; FLOWMETER V ; VELOCITY	<u>F</u> <u>V</u>
2	<i>Flow volume</i> <i>Flow velocity (in case of velocity mode)</i> Result of average flow volume or flow velocity from each path. Main unit parameters determine numerical digits and decimal fractions. Any compensation settings are included in this result.	<u>0.123</u> <u>-0.123</u> <u>12.3</u> <u>123.456</u>
3	<i>Flow volume of path no.1</i> <i>Flow velocity of path no.1 (in case of velocity mode)</i>	Same as field 2
4	<i>Flow volume of path no.2</i> <i>Flow velocity of path no.2 (in case of velocity mode)</i>	Same as field 2
5	<i>Flow volume of path no.3</i> <i>Flow velocity of path no.3 (in case of velocity mode)</i>	Same as field 2
6	<i>Flow volume of path no.4</i> <i>Flow velocity of path no.4 (in case of velocity mode)</i>	Same as field 2
7	<i>Measuring Unit for flow rate</i> This unit is set by main unit parameters. Double quotes ":" will be inserted between exponential indicators and measurement units. If the exponential indicators are set as x1, double quotes ":" are omitted and only units are indicated.	<u>m3/h</u> <u>m3/min</u> <u>E+3:m3/h</u> <u>E-3:L/s</u> <u>m/s</u> <u>ft/s</u>
8	<i>Velocity</i> During flowmeter operation mode, this value is calculated from flow volume. During velocity operation mode, this value is calculated from measured velocity with all compensation parameters such as "zero shift", "span correction" and "low-cut" functions added. Decimal fraction is fixed at 3 digits. This value will be the same as field No.2 in case of velocity mode.	<u>0.123</u> <u>1.234</u> <u>12.345</u> <u>-0.123</u> <u>-12.345</u>

9	<i>Unit of velocity</i>	<u>m/s</u> ( <u>ft/s</u> )
10	<i>Forward totalizing value</i>  7 digits If totalizing operation is not set, field will be blank.	<u>0000000</u> <u>9999999</u> "_" (blank)
11	<i>Unit of Forward totalizing</i>  This unit is set by main unit parameters. If it is not set, field will be blank.	<u>x10m3</u> <u>x5m3</u> <u>x1m3</u> <u>x100L</u> "_" (blank)
12	<i>Backward totalizing value</i>  7 digits If totalizing operation is not set, field will be blank.	<u>0000000</u> <u>9999999</u> "_" (blank)
13	<i>Unit of Backward totalizing</i>  This unit is set by main unit parameters. If it is not set, field will be blank.	<u>x10m3</u> <u>x5m3</u> <u>x1m3</u> <u>x100L</u> "_" (blank)
14	<i>"FULL SCALE" Status</i>  "FS" is indicated in case of "Full Scale" status.	<u>FS</u> "_" (blank)
15	<i>"AGC" Status</i>  "AGC" is indicated when "AGC" function is activated.	<u>AGC</u> "_" (blank)
16	<i>"Range" Status</i>  "LOW" is indicated in case of low range. Blank refers to high range status.	<u>LOW</u> "_" (blank)
17	<i>"ROFF" Status</i>  "ROFF" is indicated when ROFF warning is activated.	<u>ROFF</u> "_" (blank)
18	<i>Receiving status of Path No.1</i>  R1 is indicated in case of ROFF at Path No.1	<u>R1</u> "_" (blank)
19	<i>Receiving status of Path No.2</i>  R2 is indicated in case of ROFF at Path No.2	<u>R2</u> "_" (blank)
20	<i>Receiving status of Path No.3</i>  R3 is indicated in case of ROFF at Path No..3	<u>R3</u> "_" (blank)
21	<i>Receiving status of Path No.4</i>  R4 is indicated in case of ROFF at Path No..4	<u>R4</u> "_" (blank)
22	<i>Disturbance detection status</i>  DIS is indicated in case of "Disturbance detection" status.	<u>DIS</u> "_" (blank)
23	<i>"Limit" Status</i>  <u>OVER</u> is indicated in case of "Range Over" status.	<u>OVER</u> "_" (blank)
24	<i>(Reserved)</i>	"_" (blank)

25	<p><i>Error Status</i></p> <p>If an error occurs, an error number-code will be indicated. No error is indicated by a blank field. Refer to II-2-7 table 4-1; Error Code List for each error code.</p>	<p><u>ERR01</u> <u>ERR63</u></p> <p>"_" (blank)</p>
26	<p><i>Status of Low-Battery</i></p> <p><u>LB</u> will be indicated in case of low battery. Totalizing value can not be maintained under low battery status. Battery replacement required.</p>	<p><u>LB</u></p> <p>"_" (blank)</p>
27	<p><i>Check Status</i></p> <p>A: Analog output check, R: Fixed Range check, M: Multi-Path check "_" (blank)</p>	<p><u>C-ARM</u> <u>C-A</u> <u>C-R</u> <u>C-M</u> <u>C-AR</u> <u>C-AM</u> <u>C-RM</u></p> <p>"_" (blank)</p>
28	<p><i>Totalizing Status</i></p> <p>Operating totalizing function indications. ITG : Manual totalizing operation mode ITG@T : Timer totalizing operation mode @T : Timer-totalizing completed "_" (blank): Manual-totalizing completed</p>	<p><u>ITG</u> <u>ITG@T</u> <u>@T</u></p> <p>"_" (blank)</p>
29	<p><i>Gain value of 1<sup>st</sup> path Upper side</i> (For Firmware V1.20 or later)</p>	00~ <u>80</u>
30	<p><i>Gain value of 1<sup>st</sup> path Down side</i> (For Firmware V1.20 or later)</p>	00~ <u>80</u>
31	<p><i>Gain value of 2<sup>nd</sup> path Upper side</i> (For Firmware V1.20 or later)</p>	00~ <u>80</u>
32	<p><i>Gain value of 2<sup>nd</sup> path Down side</i> (For Firmware V1.20 or later)</p>	00~ <u>80</u>
33	<p><i>Gain value of 3<sup>rd</sup> path Upper side</i> (For Firmware V1.20 or later)</p>	00~ <u>80</u>
34	<p><i>Gain value of 3<sup>rd</sup> path Down side</i> (For Firmware V1.20 or later)</p>	00~ <u>80</u>
35	<p><i>Gain value of 4<sup>th</sup> path Upper side</i> (For Firmware V1.20 or later)</p>	00~ <u>80</u>
36	<p><i>Gain value of 4<sup>th</sup> path Down side</i> (For Firmware V1.20 or later)</p>	00~ <u>80</u>
37	<p><i>History of ROFF status</i> (For Firmware V1.20 or later)</p>	0000~ <u>9999</u>
38	<p><i>History of DIS.status</i> (For Firmware V1.20 or later)</p>	0000~ <u>9999</u>
Final Field	<p><i>Check-Sum xx+ [CR][LF]</i></p> <p>Please refer to Chap.6 for example of detailed calculations. [CR][LF] indicates sentence completion.</p>	*xx[CR][LF]

**(5) Specification for serial communication**

5-1. Hardware settings

DIGITAL port1 of main unit communication specifications are provided in Table 5.1.

Table 5.1

Communication Parameters	Value
Standard	EIA-232 (RS-232C)
Baud rate <sup>note1</sup>	4800bps, 9600bps, 19200bps ( Default; 9600bps )
Data bit	8
Parity	Even
Stop bit	1
Flow control	None
Output interval <sup>note2</sup>	Every 0~3600 seconds No output in case of "0" setting. (Default 1sec interval)

Note1

Baud rate for port 1 is set under MENU [ INP-421 : BAUD RATE#1 ] by the main unit LCD key-pad only.

Select Menu INP-421, then enter baud rate selection as below.

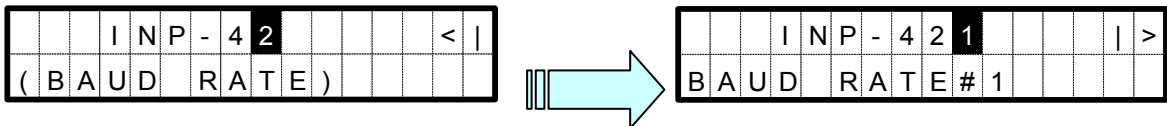

3 speeds are selectable.

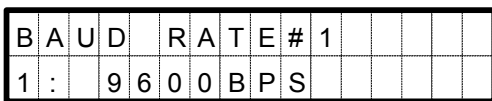

- 0: 4800bps
- 1: 9600bps (Default)
- 2: 19600bps

Note2

Output interval is set under MENU [ INP-41 ] by the main unit LCD key-pad or through commissioning software at [ Advanced - INPUT - Digital Output ].

Select Menu INP-41 from LCD Key-pad



Enter INP-41, data settings viewable.

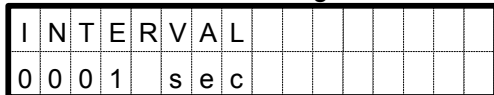

Manually change settings.

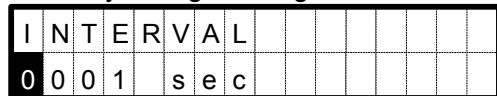

For software, set under [INPUT-Digital output].

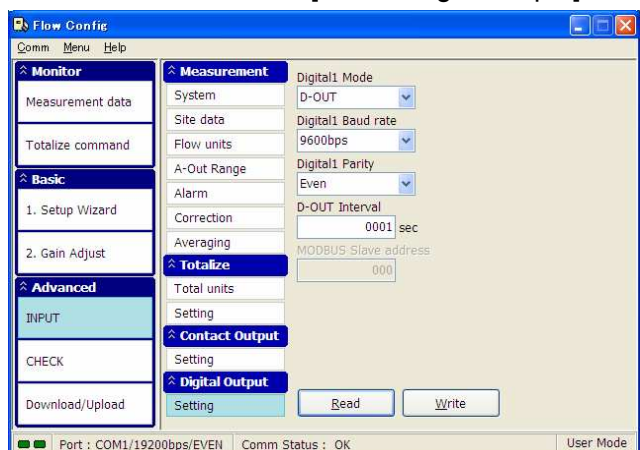



5-2. Connector Assignment

Table 5-2 shows pin assignment for DIGITAL port 1(RJ-45).

Table 5-2. DIGITAL port 1 Pin Assignment (EIA-561Standard)

Pin No.	Signal	Assignment
1	RI(DSR)	3(DTR)
2	DCD	Not Connected
3	DTR	1(RI DSR)
4	GND	GND
5	RD	Receiving
6	TD	Transmitting
7	CTS	8(RTS)
8	RTS	7(CTS)

(6) Appendix  
6-1. ASCII code list

High order digit \ Low order digit	0	1	2	3	4	5	6	7
0		DE		0	@	P	'	p
1	SH	D1	!	1	A	Q	a	q
2	SX	D2	"	2	B	R	b	r
3	EX	D3	#	3	C	S	c	s
4	ET	D4	\$	4	D	T	d	t
5	EQ	NK	%	5	E	U	e	u
6	AK	SN	&	6	F	V	f	v
7	BL	EB	'	7	G	W	g	w
8	BS	CN	(	8	H	X	h	x
9	HT	EM	)	9	I	Y	i	y
A	LF	SB	*	:	J	Z	j	z
B	HM	EC	+	;	K	[	k	{
C	CL	→	,	<	L	¥	l	
D	CR	←	-	=	M	]	m	}
E	SO	↑	.	>	N	^	n	—
F	SI	↓	/	?	O	_	o	

List 6-1 Hexadecimal description

6-2. Check-sum example

An "\*" asterisk mark and double word check sum is added to the last character of the line. Check-sum will be calculated as EXOR converted to a Hexadecimal number in accordance with the character string which begins after the \$ mark and ending with the \* mark (i.e. excluding the \* mark but including the comma).

In the example of the following line, the check-sum value will be as follows.

Sample sentence : \$,1,2,\*2F[CR][LF]  
Check-sum : 0x2F

Table 6-1 Check-sum samples

ASCII Character	ASCII Character Binary-digit (Hexadecimal-digit)	Calculated result by EXOR Binary-digit (Hexadecimal-digit)
,	0010 1100 (0x2C)	0010 1100 (0x2C)
1	0011 0001 (0x31)	0001 1101 (0x1D)
,	0010 1100 (0x2C)	0011 0001 (0x31)
2	0011 0010 (0x32)	0000 0011 (0x03)
,	0010 1100 (0x2C)	0010 1111 (0x2F)

### III-2-8 Digital output profiles (MODBUS Protocol)

#### (1) Overview

Flowmeter can provide digital data output of flowrate, velocity data, totalizing value as well as measurement status.

This digital data is output from DIGITAL port1 via EIA-232 (RS-232C) connection by MODBUS protocol when selected by commissioning software.

#### (2) Wiring Connection

Physical wiring between Main unit and digital output is as follows,

Main unit setting is done through Digital Port 2 by intercommunication mode under TOKIMEC original protocol.

MODBUS communication is output from Digital Port 1 in accordance with main unit setting.



#### CAUTION

1. Connection cable length must be less than 3 m long to comply with EC directive.
2. Do not connect the connection cable to LAN connector of the personal computer, that may damage the flowmeter main unit and/or the personal computer.
3. Make sure that connections are made correctly as incorrect connections may result in damage to the main unit and connected accessories.

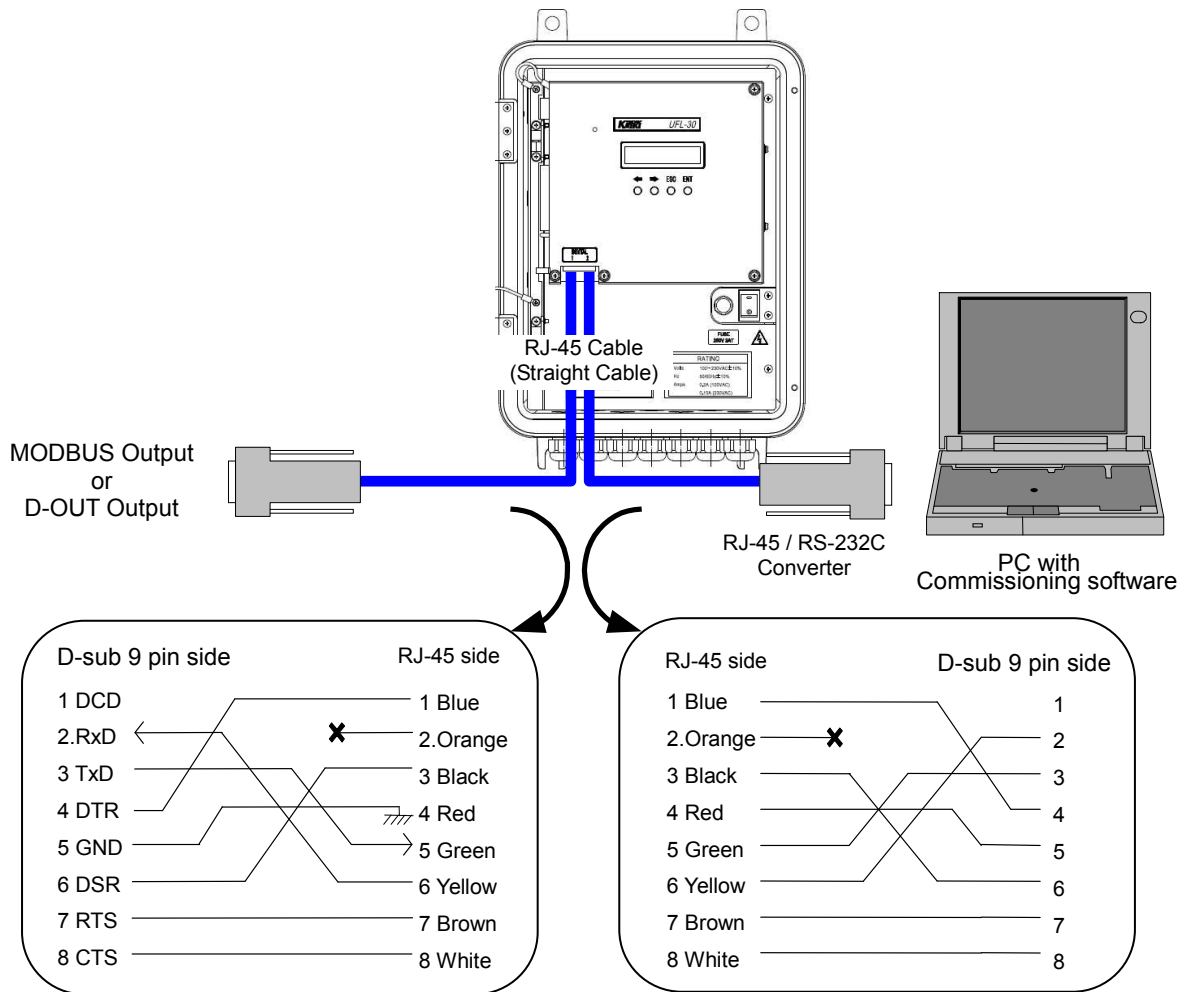

NOTE; Each "RTS and CTS", "DTR and DTS" of Digital Port 1 is shorted on flowmeter 's main unit side.

### (3) MODBUS Specification

Detail specification of MODBUS is per table 1.

Transmit mode is supported RTU mode only. TXT mode is not supported.

Table 1; MODBUS Specification

Parameters	Specification	Default	Operation
Transmit mode	RTU Only	RTU	Not selectable
Baud Rate	4800 / 9600 / 19200	9600	Set by commissioning software
Parity	EVEN / ODD / NONE	EVEN	Set by commissioning software
Bit Length	8	8	Not selectable
Stop Bit	1	1	Not selectable
Slave Address	000-247	000	Set by commissioning software
Connection	RS-232C	RS-232C	Not selectable
RS1 MODE	D-OUT / MODBUS	D-OUT	Set by commissioning software

#### Note

If you desire to maintain the IP class with digital communication, please consult manufacturer or representative. The IP class cannot be maintained with standard LAN cables (straight type) with standard skin-top connector.

### (4) Configuration for MODBUS communication

#### 4-1. Set protocol for MODBUS output on Digital Port 1

Change the "MODE" to MODBUS on the [UF-INPUT-RS-232C] tab as below display by commissioning software which connected with Digital Port 2 side.

[Setting Parameters]

- aa. MODE ; 1:MODBUS
- bb. BAUD RATE; Adapt to MODBUS master setting
- cc. PARITY ; Adapt to MODBUS master setting

#### 4-2. Set Slave Address

You can select slave address from 000 to 247.

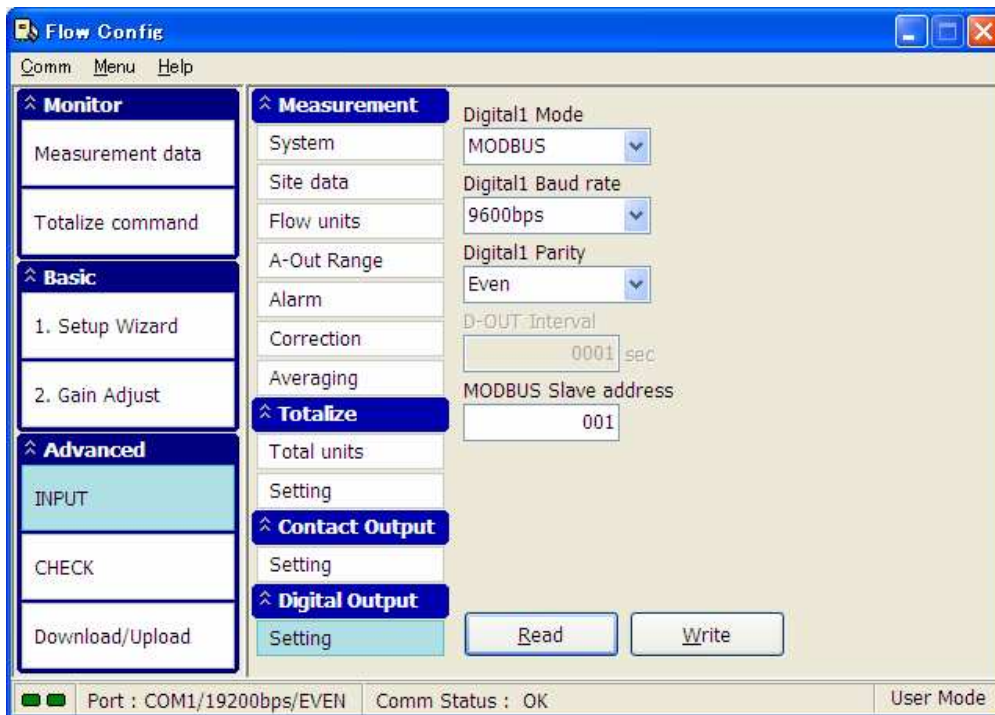

Table 2; Selectable value and default of each parameters

Parameters	Value Range	Default	Description
MODE	0: D-OUT 1: MODBUS	0: D-OUT	Protocol Selection
BAUD RATE	0: 4800bps 1: 9600bps 2: 19200bps	1: 9600bps	Baud Rate of DIGITAL Port1
PARITY	0: EVEN 1: ODD 2: NONE	0: EVEN	Parity of DIGITAL Port1
MODBUS ADRESS	000~247	001	MODBUS Slave Address
INTERVAL	1 - 3600	1second	Data Interval at D-OUT MODE

Note: "D-OUT" is default digital output by origianl protocol which defined as chapter III-2-6.

## (5) Supported Function Code

### 5-1. Function Code

Supported function code is as table 3 of below.

Table 3; Function Codes

Code	Name	Supported
01	Read Coil Status	Yes
02	Read Input Status	Yes
03	Read Holding Register	Not Available
04	Read Input Register	Yes
05	Force Single Coil	Not Available
06	Preset Single Register	Not Available
07	Read Exception Status	Not Available
08	Diagnostics	Yes
11	Fetch Communication Event Counter	Yes
12	Fetch Communication Event Log	Not Available
13	Program Controller	Not Available
14	Poll Controller	Not Available
15	Force Multiple Coils	Not Available
16	Preset Multiple Registers	Not Available
17	Report Slave ID	Not Available
18	Program 884/M84	Not Available
19	Reset Comm. Link	Not Available
20	Read General Reference	Not Available
21	Write General Reference	Not Available
22	Mask Write 4x Register	Not Available
23	Read/Write 4x Registers	Not Available
24	Read FIFO Queue	Not Available

## 5-2. [Function 01] Read Coil Status

Table 4; COIL ADDRESS

MEANING	ADDRESS	R/W	COMMENTS
BREAKDOWN	1	Read Only	
Roff	2	Read Only	No Echo receiving warning
Roff Path1	3	Read Only	R-OFF warning on 1 <sup>st</sup> Path
Roff Path2	4	Read Only	R-OFF warning on 2 <sup>nd</sup> Path
Roff Path3	5	Read Only	R-OFF warning on 3 <sup>rd</sup> Path
Roff Path4	6	Read Only	R-OFF warning on 4 <sup>th</sup> Path
HIGH LIMIT	7	Read Only	High Limit Alarm
LOW LIMIT	8	Read Only	Low Limit Alarm
FW DIRECTION	9	Read Only	Forward Flow Direction
HIGH RANGE	10	Read Only	HIGH Range Status
BATTERY ERROR	11	Read Only	Error of Backup Batter for totalizing
INTEG FLAG	12	Read Only	Totalizing activated
TIMER INTEG MODE	13	Read Only	
CHECK-MODE	14	Read Only	Check mode activated
CHECK-A	15	Read Only	Analog Check mode activated
CHECK-R	16	Read Only	Range Check mode activated
CHECK-M	17	Read Only	Path Status Check mode activated
FULL SCALE	18	Read Only	
AGC	19	Read Only	

## 5-3 [Function 02] Read Input Status

Table 5; INPUT STATUS ADDRESS

MEANING	ADDRESS	COMMENTS
EXTIN	10001	External control input status

## 5-4 [Function 04] Read Input Register

Table 6; INPUT REGISTER ADDRESS

VARIABLE	ADDRESS	TYPE	R/W	COMMENTS
Flowrate Mean (Velocity Mean)	30001	32-bit float	Read Only	Average Flow rate of all Paths (Average Velocity of all Paths)
Flowrate Path1 (Velocity Path1)	30003	32-bit float	Read Only	Flowrate of 1 <sup>st</sup> Path only (Velocity of 1 <sup>st</sup> Path only)
Flowrate Path2 (Velocity Path2)	30005	32-bit float	Read Only	Flowrate of 2 <sup>nd</sup> Path only (Velocity of 2 <sup>nd</sup> Path only)
Flowrate Path3 (Velocity Path3)	30007	32-bit float	Read Only	Flowrate of 3 <sup>rd</sup> Path only (Velocity of 3 <sup>rd</sup> Path only)
Flowrate Path4 (Velocity Path4)	30009	32-bit float	Read Only	Flowrate of 4 <sup>th</sup> Path only (Velocity of 4 <sup>th</sup> Path only)
Velocity Mean (Velocity Mean)	30011	32-bit float	Read Only	Average velocity of all Paths (Same as address 30001)
C0 Mean	30013	32-bit float	Read Only	Average of measured sonic velocity
C0 Path1	30015	32-bit float	Read Only	Measured sonic velocity of 1 <sup>st</sup> Path
C0 Path2	30017	32-bit float	Read Only	Measured sonic velocity of 2 <sup>nd</sup> Path
C0 Path3	30019	32-bit float	Read Only	Measured sonic velocity of 3 <sup>rd</sup> Path
C0 Path4	30021	32-bit float	Read Only	Measured sonic velocity of 4 <sup>th</sup> Path
FW Total	30023	32-bit Integer	Read Only	Totalized value of Forward direction
BW Total	30025	32-bit Integer	Read Only	Totalized value of Backward direction
Gain Path1Up	30027	16-bit Integer	Read Only	Setting Gain for Upper side of 1 <sup>st</sup> Path
Gain Path1Dn	30028	16-bit Integer	Read Only	Setting Gain for Down side of 1 <sup>st</sup> Path
Gain Path2Up	30029	16-bit Integer	Read Only	Setting Gain for Upper side of 2 <sup>nd</sup> Path
Gain Path2Dn	30030	16-bit Integer	Read Only	Setting Gain for Down side of 2 <sup>nd</sup> Path
Gain Path3Up	30031	16-bit Integer	Read Only	Setting Gain for Upper side of 3 <sup>rd</sup> Path
Gain Path3Dn	30032	16-bit Integer	Read Only	Setting Gain for Down side of 3 <sup>rd</sup> Path
Gain Path4Up	30033	16-bit Integer	Read Only	Setting Gain for Upper side of 4 <sup>th</sup> Path
Gain Path4Dn	30034	16-bit Integer	Read Only	Setting Gain for Down side of 4 <sup>th</sup> Path
Roff History	30035	16-bit Integer	Read Only	Number of "R-OFF" warning function worked
Dis. History	30036	16-bit Integer	Read Only	Number of "Disturbance Elimination" function worked
System Unit	30037	16-bit Integer	Read Only	Unit selection from Metric / USA
Exponent	30038	16-bit Integer	Read Only	Exponent unit for Flow rate
Flow Rate Unit	30039	16-bit Integer	Read Only	Unit for Flow rate
FW Totalizing Unit	30040	16-bit Integer	Read Only	Unit for Forward Totalizing
BW Totalizing Unit	30041	16-bit Integer	Read Only	Unit for Backward Totalizing
Error Code	30042	16-bit Integer	Read Only	Refer to below Table 7
Device Status1	30043	16bit Integer	Read Only	Same as Coil 01 ~ 16
Device Status2	30044	16bit Integer	Read Only	Same as Coil 01 ~ 16

Note; The description in ( ) is in case of velocity mode.

Description for Device Status  
Table 7; Read Exception Bit Status

Bit	Description
0	Transmitter Circuit Breakdown
1	Receiving Circuit Break down
2	Time measuring Circuit Breakdown
3	RTC RAM Breakdown
4	EEPROM Break down
5	Inputted Data Error
6	-
7	-

Above status is the same as “Function 08 Diagnostic Resister” of code 02.

### 5-5 [Function 08] Diagnostic

Table 8; Diagnostic Sub-functions

Code	Name	UFL-20A Supported
00	Return Query Data	Yes
01	Restart Communication Option	Yes
02	Return Diagnostic Register	Yes (Refer to Table 9)
03	Change ASCII Delimiter	Not Available
04	Force Listen Only Mode	Yes
05..09	Reserved	Not Available
10	Clear Ctrs and Diagnostic Register	Not Available
11	Return Bus Message Count	Yes
12	Return Bus Comm. Error Count	Yes
13	Return Bus Exception Error Count	Yes
14	Return Slave Message Count	Yes
15	Return Slave No Response Count	Not Available
16	Return Slave NAK Count	Not Available
17	Return Slave Busy Count	Not Available
18	Return Bus Character Overrun Count	Not Available
19	Return Overrun Error Count	Not Available
20	Clear Overrun Counter and Flag	Not Available
21	Get/Clear Modbus Plus Statistics	Not Available
22 up	Reserved	Not Available

Table 9; Code 02 - Return Diagnostic Resister

Bit	Description
0	Transmitter Circuit Breakdown
1	Receiving Circuit Breakdown.
2	Time measuring Circuit Breakdown
3	RTC RAM Breakdown
4	EEPROM Breakdown
5	Inputted Data Error
6	-
7	-

Above status is the same as “Function 04 Device Status”.





### III-3. Principles of the Ultrasonic Flowmeter

#### III-3-1 Measurement principles

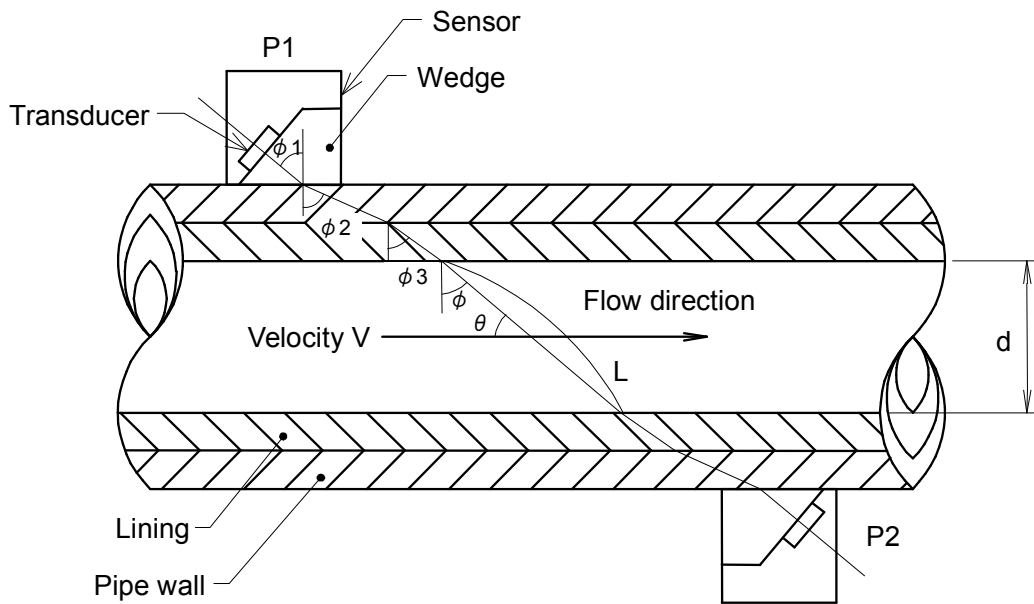

Fig. 3-1; Ultrasonic Wave Propagation Route

A sensor (called "Transducer") consists of an transducer for transmitting and receiving ultrasonic waves and a plastic wedge. Transducers P1 and P2 have the same structure and characteristics.

When an ultrasonic pulse is transmitted from the transducer of transducer P1, the pulse is propagated through the wedge and strikes the boundary with the pipe wall at angle  $\phi_1$ . The wave is then refracted and propagated through the pipe wall at angle  $\phi_2$ .

The pulse then passes through the lining at refraction angle  $\phi_3$  and through the fluid at refraction angle  $\phi$ .

When the velocity of sound is defined as  $C_1$  in the wedge,  $C_2$  in the pipe wall,  $C_3$  in the lining, and  $C$  in the fluid, the following formula can be deduced from the law of refraction.

$$\frac{\sin \phi_1}{C_1} = \frac{\sin \phi_2}{C_2} = \frac{\sin \phi_3}{C_3} = \frac{\sin \phi}{C} \quad (1)$$

The ultrasonic pulse propagated through the fluid reverses the previous path (fluid→lining→pipe wall) and is received by transducer P2. The received pulse is then converted into an electronic pulse.

The following formula can be written when the propagation time of an ultrasonic pulse from P1 to P2 (in other words the positive direction of the fluid) is defined as  $t_d$ .

$$td = \frac{d}{\sin \theta \cdot (C + V \cdot \cos \theta)} + \tau \quad (2)$$

Conversely, the following formula can be written when the propagation time of an ultrasonic pulse from P2 to P1 (in other words the reverse direction of the fluid) is defined as  $t_u$ .

$$t_u = \frac{d}{\sin \theta \cdot (C - V \cdot \cos \theta)} + \tau \quad (3)$$

In these formulas  $d$  is the internal diameter of the pipe,  $\theta$  is the angle between the ultrasonic pulse advance and the flow direction, and  $\tau$  is the fixed delay time (sum of time required for the pulse to travel through the wedge, pipe wall, and lining and the electronic delay time of the flowmeter).

Since the velocity of sound in water  $C$  is much larger than flow rate  $V$ , the following assumption can be made:  $C^2 \gg V^2 \cos^2 \theta$

Therefore, when the propagation time difference  $\Delta t = t_u - t_d$  is calculated, the following formula can be deduced from formulas (2) and (3).

$$\Delta t = t_u - t_d = \frac{2 \cdot (d/\sin \theta) \cdot V \cdot \cos \theta}{C^2} \quad (4)$$

However, the velocity of sound  $C$  included in this formula will vary depending on the fluid temperature and other factors. Therefore, with this ultrasonic flowmeter, the velocity of sound  $C$  in water is cancelled out as shown below in order to eliminate its affect.

If the propagation time in still water is defined as  $t_0$ , formula (5) can be deduced from formulas (2) and (3).

$$t_0 = \frac{t_u + t_d}{2} = \frac{d/\sin \theta}{C} + \tau \quad (5)$$

The following is then obtained by substituting formula (4) into the above formula.

$$\Delta t = \frac{2 \cdot (t_0 - \tau)^2 \cdot V \cdot \cos \theta}{d/\sin \theta} \quad (6)$$

Finally, the following is obtained by solving for  $V$  in formula (6).

$$V = \frac{d/\sin \theta}{2 \cdot (t_0 - \tau)^2 \cdot \cos \theta} \cdot \Delta t = \frac{d}{2 \cdot \sin \theta \cdot \cos \theta \cdot (t_0 - \tau)^2} \cdot \Delta t \quad (7)$$

Since the flow velocity  $V$  obtained by the ultrasonic flowmeter is an average velocity through the diameter between the transducers, the actual average velocity  $\bar{V}$  is different. The ratio between these 2 velocities is expressed using flow volume correction coefficient  $k$ , as shown below.

$$\begin{aligned} & \text{Flow volume correction coefficient } (k) \\ & = \frac{\text{Average flow velocity obtained by ultrasonic flowmeter } (V)}{\text{Actual average flow velocity } (\bar{V})} \quad (8) \end{aligned}$$

Next, flow volume  $q$  can be expressed as shown in formula (9) when the cross sectional area of the pipe is defined as  $A$ .

$$\begin{aligned} q &= A \cdot \bar{V} = A \cdot \frac{V}{k} = \frac{1}{k} \cdot \frac{\pi \cdot d^2}{4} \cdot \frac{d}{2 \cdot \sin \theta \cdot \cos \theta \cdot (t_o - \tau)^2} \cdot \Delta t \\ &= \underbrace{\left[ \frac{1}{k} \cdot \left\{ \frac{\pi \cdot d^2}{4} \cdot \frac{d}{2 \cdot \sin \theta \cdot \cos \theta} \right\} \right]}_{\text{Scale factor}} \cdot \frac{\Delta t}{(t_o - \tau)^2} \quad (9) \end{aligned}$$

Therefore, if the scale factor in formula (9) is calculated beforehand, flow volume  $q$  can be calculated from the actual measurement values of formulas (4) and (5). In other words, formula (9) shows that the affects of changes in the velocity of sound in water can be eliminated by measuring  $\Delta t$  and  $t_o$ .

Next, the flow volume correction coefficient  $k$ , expressing the relationship between the measurement velocity  $V$  and the actual average velocity  $\bar{V}$  as shown by formula (8), changes depending on the Reynolds Number. Therefore, with this ultrasonic flowmeter, the velocity  $V$  obtained from formula (7) using the ultrasonic flowmeter is further used to obtain a temporary average velocity  $\bar{V}$  using formula (10). The Reynolds Number  $Re$  expressed in formula (11) is then calculated using this temporary value.

$$\bar{V} = \frac{V}{1.05} \quad (10)$$

$$Re = \frac{d \cdot \bar{V}}{\nu} \quad (\nu; \text{Kinematic viscosity}) \quad (11)$$

Finally, the Reynolds Number  $Re$  calculated using formula (11) is used to calculate a flow volume correction coefficient  $k$ , correlated to the flow velocity, from the formula of G.E. Birger.

Since the above calculation processes are done by a microcomputer, accurate flow volume measurement is possible.

### III-3-2 Transmission and reflection methods

With ultrasonic flowmeters, depending on the propagation route of the ultrasonic waves, the measurement methods can be divided into the transmission method (Z method) and the reflection method (V method) as shown in Fig. 3-2. Since the above explanation of measurement principles used the transmission method, the reflection method will be explained here. An advantage of the reflection method is the ability to consistently obtain correct measurement values even when some flowing components move perpendicular to the flow direction. These situations include circling flow, etc. However, since the propagation route of the ultrasonic waves is approximately twice the length of the route with the transmission method, larger propagation loss occurs.

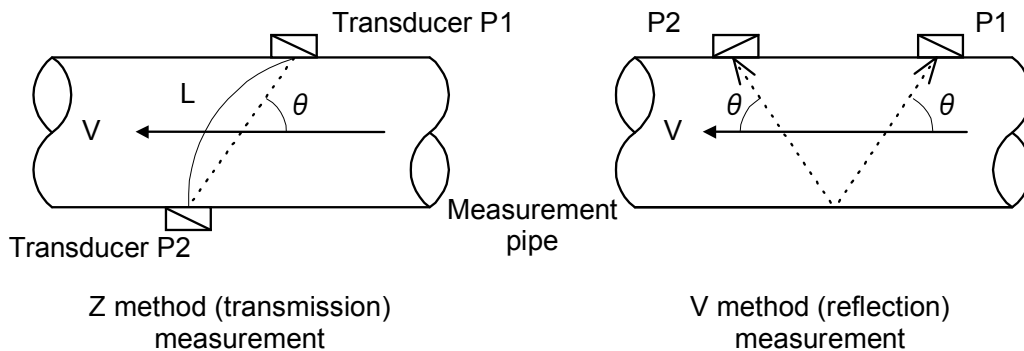

Fig. 3-2; Measurement Methods

With the reflection method, although the internal diameter is doubled, as shown in the figure below, the flow rate is the same and the calculation formulas of the transmission method are applicable. Therefore,  $d$  is changed to  $2d$  and the scale factor is cut in half. Aside from such small changes, the same formulas are generally used.

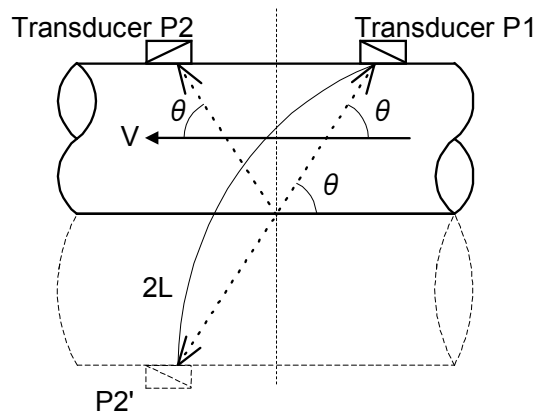
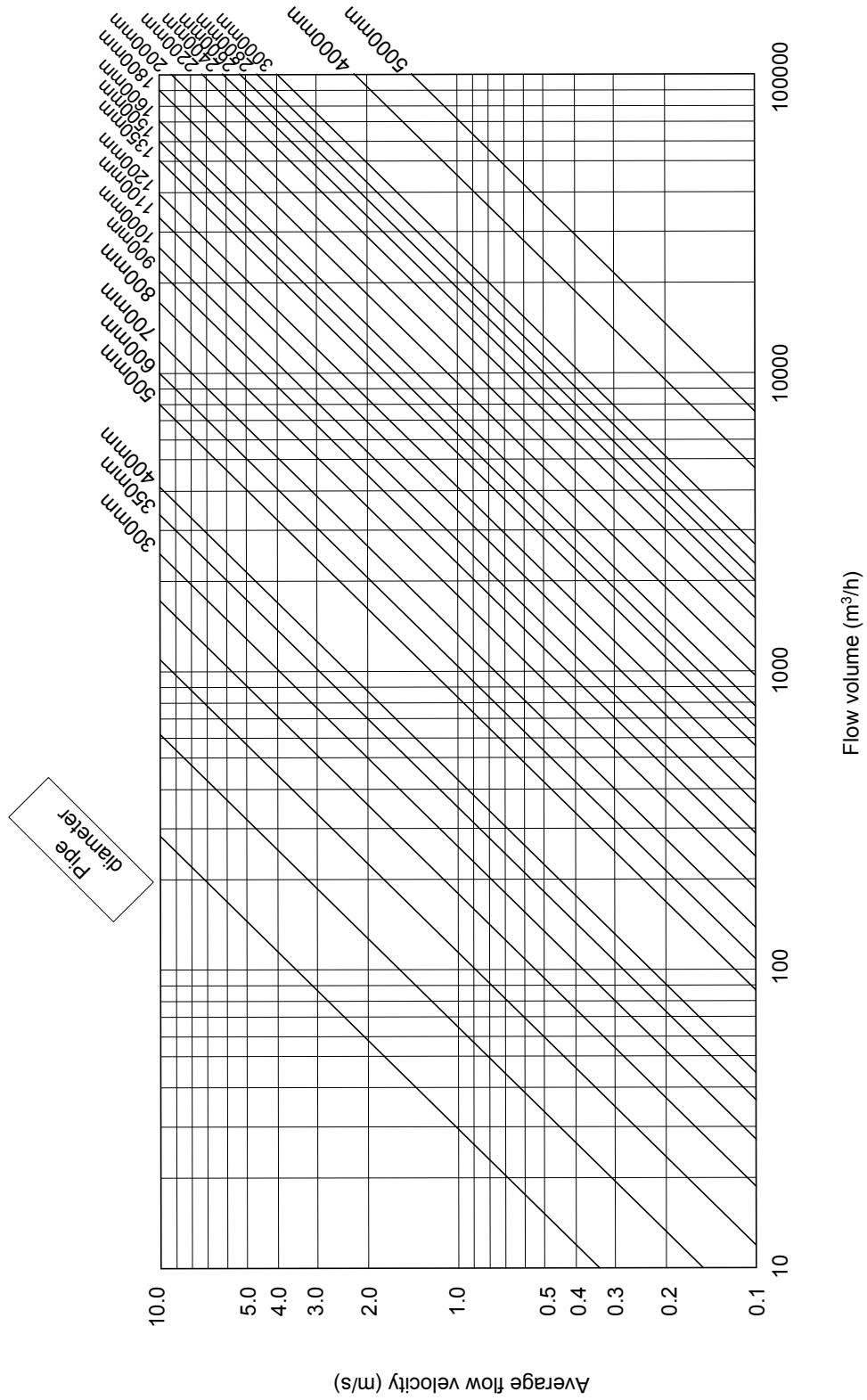

Fig. 3-3; Explanatory Diagram for Reflection Method

### III-4 Appendix

#### III-4-1 Flow volume and average flow velocity



### III-4-2 Pipe conditions and required straight pipe length

[Refer to JEMIS 032-1987.]

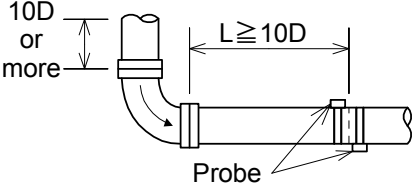
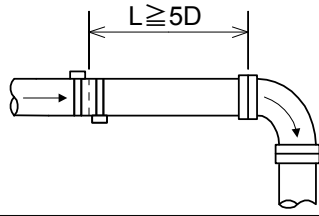
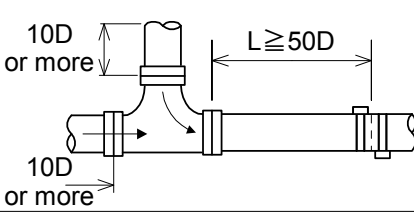
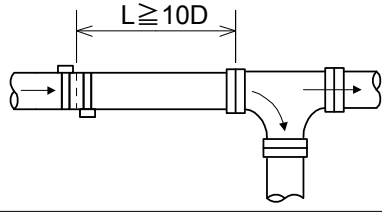
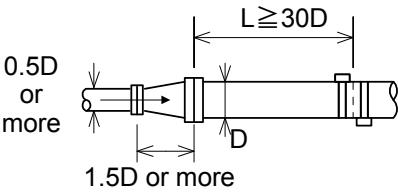
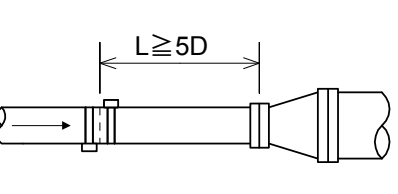
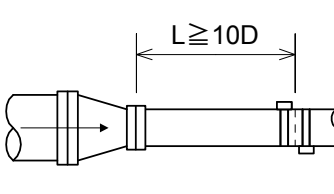
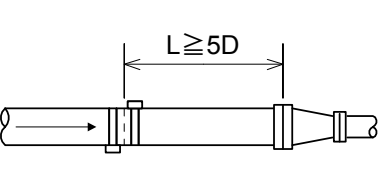
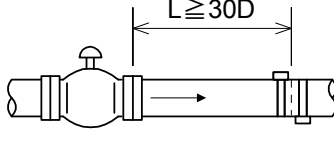
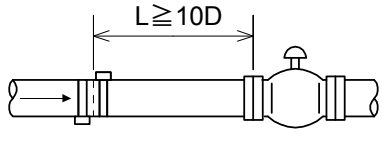
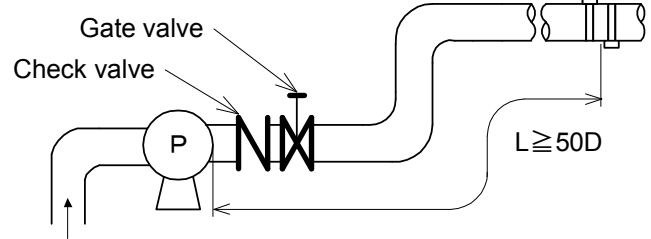
Section	Upstream straight pipe length	Downstream straight pipe length
90° bend		
T		
Expanding pipe		
Contracting pipe		
Various valves	 <p data-bbox="483 1532 834 1590">When flow volume is adjusted at the upstream valve.</p>	 <p data-bbox="962 1532 1313 1590">When flow volume is adjusted at the downstream valve.</p>
Pump		

[D: pipe diameter]

### III-4-3. Sound Velocity & Kinematic Viscosity reference list

Main unit uses following value for internal setting parameter, but those values are considered as nominal.

#### a. Pipe material reference

Material type	Material Name	Velocity Longitudinal wave (m/s)	Velocity Shear wave (m/s)
Metal	Copper	4660	2260
	Inconel	5720	3020
	Ductile Iron	5800	3000
	Cast Iron	4500	2500
	Monel	6020	2720
	Nickel	5630	2960
	Carbon Steel	5730	3200
	Stainless Steel	5790	3100
	Tantalum	4100	2900
	Titanium	6070	3110
Plastic	Polycarbonate	2300	
	Poly Vinyl Chloride	2280	
	Teflon	1390	
	Acrylic	2720	

#### b. Lining material reference

Material type	Material Name	Velocity Longitudinal wave (m/s)	Velocity Shear wave (m/s)
Lining	Epoxy	3000	2000
	Mortar	3800	2350
	Rubber		1900



c. Fluid material reference

Material type	Material Name	Composition Formula	Density (g/cm <sup>3</sup> )	Velocity Longitudinal wave (m/s)	Viscosity (×10 <sup>-6</sup> m <sup>2</sup> /s)
Alcohol	Butyl		0.71	1270	3.695 (25° C)
	Butanol		0.81	1268 (20° C)	3.239 (25° C)
	Ethanol	C <sub>2</sub> H <sub>5</sub> OH	0.79	1127 (30° C)	1.39 (25° C)
	Ethylene Glycol	>99.5%	1.11	1689 (20° C)	17.208 (25° C)
	Methanol	CH <sub>3</sub> OH	0.8	1090 (30° C)	0.695 (25° C)
Oil	Diesel Oil			1250	
	Gasoline	C <sub>8</sub> H <sub>18</sub>	0.717	1250	0.574 (25° C)
	Glycerine	C <sub>3</sub> H <sub>8</sub> O <sub>3</sub>	1.26	1920	757.1 (25° C)
	Gravity Fuel Oil AA		0.99	1490	
	Kerosene		0.81	1320	1.5 (25° C)
	Motor Oil	SAE 20	0.87	1740	5.6~9.3 (100° C)
	Motor Oil	SAE 30	0.88	1700	190 (25° C)
	Baby Oil			1416 (23° C)	
	Mineral-Heavy		0.843	1460	140 (15° C)
	Mineral-Light		0.825	1440	3 (25° C)
	Phenylated Silicone		1.1	1370	
	Silicone 1000 cSt		0.972	990	1000
	Silicone 100 cSt		0.968	980	100
	Silicone 10 cSt		0.94	968	10
	Silicone 1 cSt		0.818	960	1
	Olive Oil			1449 (23° C)	100 (25° C)
	Lubricant	Mobil		1417 (20° C)	31.5 (40° C)
Paraffin Oil			1428 (20° C)		
Solvent	Acetone		0.791	1158	0.399 (25° C)
	Benzene	C <sub>6</sub> H <sub>6</sub>	0.88	1310 (25° C)	0.711 (25° C)
	Chloro Benzene	C <sub>6</sub> H <sub>5</sub> Cl	1.11	1300 (22° C)	0.722 (25° C)
	Toluene			1420	
Water	Water		1	1460 (13.5° C)	1.208
	Water		1	1550 (60° C)	0.475
	Sea Water		1.026	1500	0.955 (25° C)

### III-5. FAQ

#### III-5-1. Measurement method

##### 1.1 What is ultrasound?

Ultrasound refers to acoustic waves or vibrations of a frequency beyond the range of human hearing (generally above 20,000 Hz).

##### 1.2 At what frequencies do ultrasonic flowmeters operate?

The frequency generally utilized is 0.4 MHz (400kHz).  
For small diameter ( $D < \varnothing 300\text{mm}$ ) pipes, 1MHz (1,000kHz) is used.

##### 1.3 Why are such high frequencies used?

Frequencies in the normal range (i.e. in the audible range) are apt to mix with and become lost in the ambient noise.

As acoustic wave frequencies become higher, they share properties similar to light such as

- (1) rectilinear propagation
- (2) refraction
- (3) reflection

and are in accordance with the laws of physics which lends itself to analysis.

##### 1.4 Is ultrasound harmful to humans or animals?

No. Ultrasound is increasingly being used in the medical field in place of X-rays.

##### 1.5 How does ultrasound measure flow?

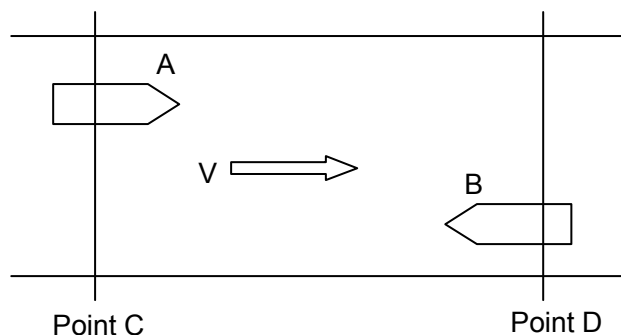

Fig. 3-5-1

Let us illustrate this by an example of two boats, 'A' and 'B', positioned at two points on a river as shown in Fig. 9. If boats 'A' and 'B' approach each other at exactly the same speed, the time, ' $t_A$ ', it takes for boat 'A' to arrive at point 'D' and the time, ' $t_B$ ', it takes for boat 'B' to arrive at point 'C' will be the same.

Now what would happen if the river is flowing at velocity 'V' in the direction of the arrow as shown? What happens is that boat 'A' which is proceeding downstream will arrive at point 'D' faster than boat 'B' which is traveling upstream. In other words, time ' $t_B$ ' is longer in comparison to time ' $t_A$ ' which reflects the additional time involved in opposing the flow, and thus time, ' $t_A$ ' for boat 'A' which is traveling downstream to arrive at point 'D' will be faster. This

time difference is proportional to the magnitude of the velocity of the flow and this principle is utilized to measure flow velocities. This can be expressed by the formula:

$$t_B - t_A = \Delta t$$

where  $\Delta t$  is the time difference. This time difference can be calculated precisely with a clock pulse generated by a microcomputer to accurately measure flow.

As flow velocity ' $V$ ' can be determined by measuring  $\Delta t$ , you can calculate the volume of flow through a pipe or open channel by multiplying  $\Delta t$  by the cross sectional area of the pipe or open channel. In such calculations, it is necessary to employ a flow volume compensation coefficient with the measured flow velocity ' $V$ ' in order to obtain average flow velocity.

#### 1.6 Is the time difference method the only method used in ultrasonic flow measurement?

Presently there are three measurement methods in practical use.

- (1) Frequency difference method
- (2) Time difference method
- (3) Doppler method

Methods (1) and (2) are mainly used for measurement of relatively clean water. This is because fluctuations in propagation level of ultrasonic signals (i.e. sensitivity of ultrasonic transmissions and reception) become problematic with dirty water which reduces signal strength.

Measurement method (3) involves detection of frequency shifts (changes) in acoustic signals. As changes in signal propagation level is not directly a factor, this method is suitable for measurement of dirty water such as sewage.

#### 1.7 Does acoustic velocity vary with water temperature?

Yes. It is thus important to devise means to overcome the affect of acoustic velocity changes caused by changes in water temperature.

#### 1.8 Can measurement errors be caused by changes in water temperature?

The flow volume calculation formula employed by the flowmeter's CPU automatically compensates for the effect of water temperature changes. Therefore for all practical purposes, there are no problems with errors caused by water temperature changes.

## III-5-2. Measured fluids

### 2.1 Measured fluids

In principle, any liquid, which allows stable propagation of ultrasonic waves, can be measured. However in liquids where large amounts of air bubbles or solid particles are present, problems such as mis-measurements or non-measurable conditions may occur. As high temperature and high pressure liquids (oil, etc.) cannot be described categorically, consult manufacturer or local representatives when measuring such liquids.

### 2.2 Can raw water be measured?

River water and raw water can be measured in addition to clean water.

### 2.3 In the case of raw water, how does turbidity affect measurement?

Two separate questions arise with regard to this.

- (1) Do changes in turbidity produce measurement error?
- (2) Does high turbidity attenuate acoustic signals creating non-measurable conditions?

Regarding (1), if the penetration of acoustic signals is adequate, changes in turbidity does not normally cause errors.

Regarding (2), although related to attenuation of acoustic signals by solid particles in the liquid, exceedingly high levels of turbidity does cause reduction in signal. Tokimec specifies turbidity levels up to 10,000 in the case of a pipe diameter of 1m. (Note: turbidity of 1g of refined Kaolin clay in 1 liter of water is 1,000.)

Turbidity of 5,000 is quite severe, but as turbidity of river water rarely exceeds 1,000, there should be no problem for all practical purposes.

### 2.4 How is measurement affected if air enters the pipe?

- (1) Compared to water, air is a very difficult medium for the transmission of acoustic signals. Therefore when pumps continuously draw air into the piping, air bubbles will pass through the acoustic signal transverse path resulting in measurement swings or mis-measurements.
- (2) Also in cases where the depth of the tap from the water surface to the top of the pipe at the intake location is insufficient, air will be sucked into the pipe and may cause mis-measurements or create non-measurable conditions.
- (3) If air accumulates at the upper part of the pipe, although flow measurement can be carried out, the flow indicated will be larger than the actual flow. (Note: If the sensors are located vertically on the pipe, measurement cannot be done if there is a layer of air in the pipe.) Thus, in cases where there may be accumulation of air in pipes, air bleed valves should be installed fore and aft of the measurement position.

### 2.5 Can waste water be measured?

From the standpoint of turbidity, there are no problems with measuring waste water inflows or discharges. However pipe conditions in selecting measurement location should be carefully considered as air bubbles are apt to be generated when there are drops or when measuring locations are directly aft of pump discharge outlets.

### 2.6 Can measurements be made if solid particles or debris are present in the fluid?

The beam width (radiating width) of acoustic waves are sufficient to enable stable measurement in the presence of small-sized solid particles in the fluid. In the case of large size debris which can obstruct acoustic signals, the flowmeter has a discrimination function which can differentiate such conditions from normal measurement values and ignore such data input. However when there is continuous flow of fluid containing large volume of solid particles and debris, problems such as mis-measurements or non-measurable conditions are apt to occur.

## III-5-3. Pipes

### 3.1 What kind of pipe material enables ultrasonic measurement?

We have had numerous experiences with measurements through steel, stainless steel, cast iron, ductile iron, and resins.

(1) Although we have measured through RC steel pipes, transmission of acoustic signals is difficult and this type of pipe material is not conducive to ultrasonic measurement.

(2) Measurement through pipes of asbestos material is possible on rare occasions, but for all practical purposes, measurement is not possible with this material.

(3) Hume pipes cannot be measured with sensors mounted on the outside of the pipe. Special measurement methods incorporating sensors on the inside of the pipe are employed for this type of application.

### 3.2 What are the minimum and maximum measurable pipe sizes?

Measurable diameters are from  $\varnothing 25\text{mm}$  to  $\varnothing 6000\text{mm}$ .

### 3.3 Is pipe lining a problem?

Mortar, epoxy and other common linings on the inside of pipes do not affect measurement. In cases where the outside of pipes are wound with jute or similar material, remove this material at the location where the sensors are to be positioned.

3.4 Are there problems with lining detachment from the pipe interior?

Centrifugal force is generally used to bond linings to the interior of pipes and during operation and the pressure of the water also acts on the lining, so problems with lining detachments are few. Should such problem occur however, as long as the sensors are not positioned directly at that point, there should be no adverse affect on measurements. Even if a slight separation of lining occurs at the point of measurement but not a complete detachment from the pipe wall, water would fill the space between the lining and the wall, and any deviations may be corrected for by readjusting the sensitivity of the system. Although not a sure method, a system readjustment or change in transducer position may enable measurement even in the case of lining separation.

3.5 How does rust or rust scale on the pipe interior affect measurement?

Rust spots in some places in cast iron pipes do not affect measurement. However extensive rust on entire surfaces may cause errors or mis-measurements. For example, a 1mm accumulation of rust scale on the entire interior surface of the pipe of  $\varnothing 1,000\text{mm}$  will result in a measurement error of approx. 0.7%.

### III-5-4. Installation location

4.1 What straight length of pipe is necessary?

The general upstream straight pipe length necessary for ultrasonic measurement to achieve fully developed and rotating symmetrically is more than 10D ('D' being the upstream pipe diameter), and more than 5D downstream in order to ensure measurement accuracy.

Please reference Chapter III-4-2 'Pipe conditions and required straight pipe length'.

4.2 Can the required upstream straight pipe length be shortened similar to electric magnetic flowmeters?

Basic specifications for ultrasonic flowmeter measurement is based on 1 path measurement (single axis of measurement), but it may be possible to achieve stable measurement even shorter than the straight pipe length requirement if multi-path measurement (2 or 4 paths) is employed.

4.3 What is the affect on measurement if water enters the pit (measurement equipment chamber)?

The standard sensors are of waterproof construction conforming to IP67.

Submersible transducers (IP68) are also available (option). However long periods of submersion tends to accelerate degradation of transducers, so as much as possible sensors should not be submerged.

#### 4.4 Can sensors be buried in the ground?

When pipes are laid underground, sensor mounting position is susceptible to shifting due to soil pressure. In addition, if a problem occurs sensors must be dug out which poses maintenance problems. As such standard specification transducers cannot be buried.

However there are optional sensors which employ special specification fixtures which allow use in buried applications. There are restrictions to their use however, so please consult Tokimec.

#### 4.5 How far apart can the flowmeter unit and transducers be placed?

Coaxial cable is used to connect the main flowmeter electronic unit to the transducers. Coaxial cable length is limited to 300m. However installation should also take into consideration external noise interference.

#### 4.6 Why is a special trough needed for laying of coaxial cable?

Receiving signals of the sensors are very weak electrical signals and they are as such susceptible to interference from other equipment. In addition to signal interference from power supply lines and output signal lines, interference via coaxial cables is a principal cause of problems. Main causes of signal interference include the following.

(1) High current lines which emit noise pulsations. Examples are power transmission lines which open and close valves which run parallel to the coaxial cables.

(2) Broadcasting signals are normally not a problem, but if the cables are located directly below such stations, for example, noise interference may result.

(3) AC equipment (motors), etc. are normally not a problem, but as described above, there may be interference caused during the opening and closing of circuits

(4) Rectifier equipment, etc., may also cause problems. (The flowmeter itself should not be located nearby to a rectifier.)

#### 4.7 Can the coaxial cables be suspended in the air?

Compared to buried cable, suspended cable is more susceptible to exogenous noise. As such installation also exposes the cable to lightning and thunder, coaxial cables should not be suspended aurally.

#### 4.8 What are the recommended installation locations for the main flowmeter electronics unit?

The main flowmeter unit should be located where humidity is minimum and where it is not exposed to corrosive gases such as chloride or to direct sunlight. An air conditioned room is ideal but please select a site which falls within a basic air temperature range of -10 to +60°C.

If the flowmeter is to be located on site, it should be placed in a chamber, pit or enclosure.

Environmental conditions should be taken into consideration with measures such as interior enclosure insulation and installation of a ventilation fan as necessary.

Equipment is NOT EXPLOSION PROOF, so the flowmeter must not be located in an explosive environment.

#### 4.9 What are 'Z' and 'V' methods of measurement?

These refer to transducer placements. The Z (through-transmission or single-traverse) method is where the transducers are mounted diametrically opposite each other and the ultrasonic signal is transmitted directly from one transducer to the other across the pipe. This method is used when the pipe is of adequate diameter or for pipes where acoustic signals are greatly reduced.

With the V (reflection or double traverse) method transducers are mounted on the same side of the pipe and the ultrasonic signal is bounced from one transducer to the other off the opposite pipe wall. This method is devised to measure flows that are not linear with the pipe axis and which are not affected by radial flow velocity components. The applicable diameters for the V method depends on pipe material but is generally less than  $\varnothing 2,000\text{mm}$ .

See Chapter III-3-2 for more detail on the through transmission and reflection methods.

#### 4.10 What are single path and dual path methods of measurement?

Single path is the standard method of measurement. With the Z method, transducers are mounted opposite side of the pipe as shown in Fig. 3-5-2.

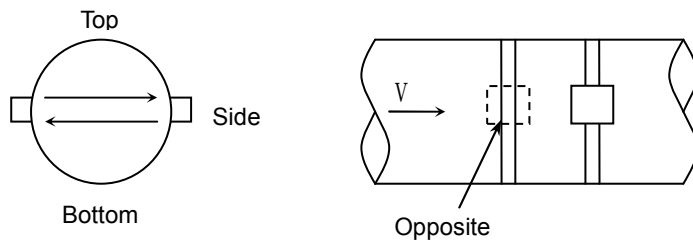

Fig. 3-5-2

With dual path measurement, two pairs of transducers (4 pcs) are mounted on the pipe as shown in Fig. 3-5-3. Compared to single path measurement of flow velocity along 1 path (diametrical axis), the dual path method measures flow velocity along 2 paths (diametrical axis) as shown in Fig. 9-3. The values of the two flow velocity measurements obtained are averaged to lessen the affect of distortions in flow velocity distribution over the pipe cross section providing more stable measurements.

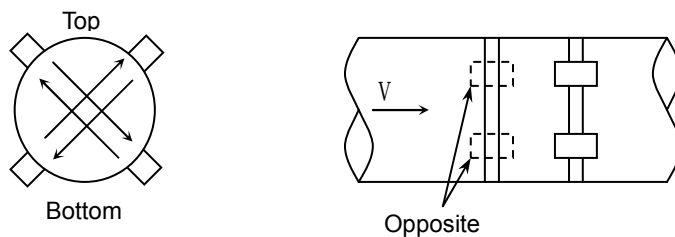

Fig. 3-5-3

With four path measurement, four pairs (8 pcs) of transducers are mounted on the pipe to provide measurement along 4 paths (diametrical axis) and the average of each measuring velocity is taken, the affect of flow velocity distribution distortions are further lessened.



### III-5-5. Other

#### 5.1 What is the foremost advantage of ultrasonic flow measurement over other types of flow measurement?

- (1) The equipment can be installed on existing pipes without interrupting flow and as such is ideal in applications involving facilities management.
- (2) Transducers are non-intrusive and do not obstruct flow or cause head losses.
- (3) There is no great cost difference relative to pipe size diameter so compared to other types of measurement, it is comparatively low cost when large diameter pipes are involved.

#### 5.2 Can the equipment be linked to telemeters or higher order computer systems?

As unified DC 4 - 20mA output signals for momentary flow are provided, the equipment can be linked with other types of measurement equipment. Also the exchange of totalized flow data can be accomplished through relay pulses. If BCD code output is desired, you can specify an optional BCD converter. In addition, RS232C output is also provided.

#### 5.3 Does maintenance involve a lot of work?

As the hardware does not employ any moving parts, there is no need for lubrication, scouring, or mechanical adjustments. Electronic circuits include long life solid state CPU's and IC's which do not require daily maintenance. See Chapter III-1 'Maintenance and Inspections'.

#### 5.4 Even with pipe diameter and flow volume information, isn't the calculation of flow velocity cumbersome?

Certainly, determining cross sectional area from the diameter of the pipe, and dividing flow volume by the cross sectional area to calculate flow velocity may be a bit troublesome. This task can be aided by the graph in Chapter III-4-1, 'Flow volume and Average Flow Velocity'. The vertical axis of the graph is the average flow velocity, the horizontal axis - the flow volume, and the diagonal lines represent various pipe diameters. As an example, for a pipe diameter of  $\varnothing 600\text{mm}$ , find the applicable diagonal. If the flow volume is  $1,000 \text{ m}^3/\text{h}$ , proceed up from the horizontal scale at  $1,000 \text{ m}^3/\text{h}$ , until you intersect the  $\varnothing 600\text{m}$  diagonal and then angle  $90^\circ$  to the left to the corresponding point on the vertical scale to determine flow velocity. In this case, flow velocity will be  $1\text{m/s}$ . For full scale flow, operating flow, and minimum flow volumes, it is simpler to consider these in terms of flow velocity and use of the graph in Chapter III-4-1, 'Flow Volume and Average Flow Velocity' is recommended.

## III-6. Troubleshooting

### III-6-1. Main flowmeter (electronics) unit and components

In the event of problems, please review this section to identify causes and suggested remedies. If the steps shown in this section cannot solve a problem, contact Tokimec.

- Unit does not startup when the system is powered up.
  - Is the main circuit breaker activated?
  - Is the fuse burned out?
- LCD display is dim.
  - Was contrast adjusted? (See Chapter II-2-3, 'LCD and Operation Keys')
  - Has the specification life been exceeded?
- Setting cannot be done by PC (no communication).
  - Are cables connected?
  - Is the correct PC port selected?
  - Does the transmission baud rate for flowmeter and PC match?
  - Is the communication environment (speed, data length, parity) set correctly?  
(See Chapter III-2-2, 'Main Unit Specifications, Digital output')
- Flow output values of BCD converter and main unit display value do not match.
  - Is the refresh rates appropriate (change INP-41: INTERVAL from menu)?  
Values are not simultaneously the same.
- Totalized value disappears when power is shut down.
  - Is backup battery dead? (Does 'B' mark appear?)
- Flow values do not vary.
  - Does 'R', 'D' marks or 'ERR\*\*' appear? (Values are held)
- Analog output does not vary.
  - Is analog check mode activated? (Is <A > displayed?)
- Relay output does not operate.
  - Was relay output allotted?  
(Set with 'INP-311: RELAY PARAM#1~INP314: RELAY PARAM#4' of menu.)
- No reverse flow totalized display.
  - Is analog output pattern set for 1 direction only?  
(Set with 'INP-211:+INT.UNIT' of menu.)
- No display of forward flow totalized units
  - Were totalized units set?  
(Set with menu, 'INP-211:+INT.UNIT' )
- Circuit breaker actuates when power is turned on.
  - Does power exceed circuit breaker rating?  
(See Chapter III-2-2 'Main Unit Specifications, Rush Current')

### III-6-2. Measurement

The following is a description of some general problems and remedies relating to measurement. If the steps shown in this section cannot solve a problem, contact Tokimec.

#### (1) Pipes which cannot be measured

- Asbestos  
If the pipe surface is sufficiently wet, measurements can be made in some cases but generally is difficult with this pipe material.
- Zinc coating pipe  
Propagation of ultrasonic waves through the material itself is markedly poor and measurement is generally difficult.
- FRPM  
Ultrasonic wave attenuation through composite material is large with  $\varnothing 2000\text{mm}$  about the largest measurable diameter based on our experience.  
In addition composites vary according to the manufacturer. Therefore in cases of large diameter pipes, pre-checks (i.e. to determine permeability of acoustic signals) should be carried out.
  - It is suggested that the portion of the piping at the measured location such as in the enclosure or pit be changed to metal piping.

- 
- Pronounced scaling and rust on the inside of pipes causes attenuation and diffusion of acoustic signals and the drop in transmission and receiving sensitivity sometimes makes measurement impossible.
    - In such cases, a better measurement location (for example an area where there is little rust) might be found by shifting sensor positions which should improve signal reception. Care should be exercised when doing this however as a narrower flow cross sectional area may output results which are not true flow values.

#### (2) Fluids which cannot be measured

- The presence of continuous and large amounts of bubbles in the fluid will greatly attenuate the acoustic signal, cause missed measurements, or make measurement impossible. Even ultrasonic flowmeters employing the Doppler method which works better under such entrained bubble conditions compared to transit-time flowmeters also encounter missed measurements or are unable to make measurements when there is a continuous and large amount of bubbles contained in the fluid being measured.
  - If the cause of bubbles is a drop in level upstream, lessen the drop.
  - When there is a layer of air in the pipe, install an air bleed valve forward of the measurement location.
  - Select measurement location where fluid contains few bubbles.

### **(3) Given measurement accuracy cannot be obtained**

- Check pipe specification.
- Insufficient straight pipe length
  - Required straight pipe length may vary according to changes in pipe conditions forward and aft of the measurement position (merged or separating flows, presence of valve, etc.)
  - Distortions in fluid velocity distribution may be exacerbated by insufficient straight pipe lengths which adversely influence measurement resulting in poor accuracy.  
In such cases employing multi-path measurement reduces the affect of such distortions in fluid velocity distribution.
- Cause may also be attributable to changes in fluid cross sectional area due to pipe rust and scale and partially filled pipe conditions.

### **(4) Measurement values are unstable**

- Entrained bubbles or solid particles in the fluid may cause fluctuation or spikes in measurements or create non-measurable conditions.
  - Eliminate the sources of these problems.
- Cavitation occurs.  
Cavitation sometimes occurs when butterfly valves are used (except for butterfly valves specially designed to prevent cavitation).
  - When there is cavitation from entrained air, select a measurement position sufficiently distanced from such locations and where the bubble problem ceases to exist.
- Exogenous noise  
Electrical signals received by ultrasonic flowmeters are generally are very weak - in the order of a few mV's - and as such ultrasonic flowmeters are susceptible to power surges and noises.
  - When there is the possibility of external noise interference on ultrasonic flowmeter measurement, check the layout and the grounding of each cable. In the case of noise intrusion (especially on sensor cables) from an AC power source, installation of a shielded transformer, etc., is effective. However the high magnitude of noise interference from inverters sometimes invalidates such countermeasures.



Document No. KF08-001  
Ultrasonic Flowmeter UFL-30  
Installation & Operation Manual  
December 2008 1<sup>st</sup> Edition (Rev.02)

**TOKYO KEIKI INC.**  
Control Division 1  
2-16-46, Minami-Kamata, Ohta-ku,  
Tokyo 144-8551, Japan  
TEL: +81-3-3737-8621  
FAX: +81-3-3737-8665  
Web: <http://www.tokimec.co.jp/>

Copyright 2008 by TOKYO KEIKI INC. All rights reserved.  
(Specifications are subject to change without notice.)